

GROTIME

CORBY COT 30247



Cot



Toddler bed



Two adults are required to assemble this cot



Follow all manufacturer's assembly instructions carefully to ensure the safety features of the cot are not compromised

Grotime

110-114 Old Bathurst Rd,
Emu Plains, NSW 2750

P.O. Box 487, Emu Plains,
NSW 2750

Customer Care

Email: customercare@infa.com.au

AUSTRALIA
1300 92 4632
www.grotime.com.au

NEW ZEALAND
067 590 870
www.grotime.co.nz



WARNING:

RETAIN FOR FUTURE REFERENCE.

READ ALL INSTRUCTIONS CAREFULLY BEFORE ASSEMBLY AND USE OF THIS COT. KEEP INSTRUCTIONS FOR FUTURE USE.

ALWAYS FOLLOW THE INSTRUCTIONS.

THE CORRECT USE AND MAINTENANCE OF THIS PRODUCT IS ESSENTIAL.



WARNING



- ADULT ASSEMBLY REQUIRED.
- FOLLOW THE MANUFACTURER'S ASSEMBLY INSTRUCTIONS TO ENSURE THE SAFETY FEATURES OF THE COT ARE NOT COMPROMISED.
- DUE TO THE PRESENCE OF SMALL PARTS DURING ASSEMBLY, KEEP OUT OF REACH OF CHILDREN UNTIL ASSEMBLY IS COMPLETE.
- TO PREVENT FALLS, THE MATTRESS BASE OF THIS COT SHOULD BE ADJUSTED TO THE LOWEST POSITION BEFORE THE CHILD CAN SIT UP.
- RECOMMENDED MATTRESS SIZE:
THIS COT HAS BEEN MANUFACTURED FOR USE WITH A MATTRESS WHICH MEASURES **1320 MM LONG x 700 MM WIDE x 120 MM THICK (SOLD SEPERATELY)**.
- The width and length are specified because it is important that the gaps between the mattress and the sides and ends of the cot will not exceed 40mm when the mattress is pushed to one side or end, and 20mm when the mattress is centred in the cot.
This is to minimise the risk of a child's limb becoming caught in the gap.
- The thickness of the mattress has been specified to ensure that the depth of the cot is greater than 500 mm with the mattress base in the lower position to minimise the risk of a child climbing or falling out of the cot.
- Use only accessories as recommended by the supplier.
- Failure to follow warnings and instructions could result in serious injury or death.
- This cot has been manufactured for one child only. Suitable from birth.
- When the mattress base is assembled in the lower position, ensure the higher cot base holes are covered tightly with the filling bolts supplied. This is to prevent finger entrapment, swallowing and inhalation hazards.
- **ENSURE** the cot is placed at a reasonable distance from curtains, blinds, heaters and power points.



WARNING:

- **ENSURE** that the child is clear of any moving parts when adjusting the cot. For warranty purposes, keep your sales receipt to provide proof of purchase.
- **ENSURE** the cot is completely assembled and check that all parts are securely tightened before placing the child into the cot.
- **ENSURE** medication, string, elastic, small toys or small items such as money etc are always kept out of the child's reach when in the cot.
- **ENSURE** that infant should be placed to sleep on a firm, flat surface.
- **ENSURE** place infant on their back when using this product.
- **ENSURE** do not put object or accessories in an infant's sleep environment.
- **DO NOT** place the product near a blind, cord, strap or similar item that could become wrapped around an infant's neck.
- **DO NOT** over tighten bolts/screws.
- **Check** this product regularly before using it, and do not use it if any part is loose or missing or if there any signs of damage, Do not substitute parts. Contact the manufacturer if replacement parts or additional instructions are needed.
- To reduce the risk of Sudden Infant Death Syndrome (SIDS), paediatricians recommend healthy infants be placed on their backs to sleep, unless otherwise advised by your physician.

SUFFOCATION HAZARD – Infants can suffocate;

- In gaps between an extra pad or mattress.
- In soft bedding.

Part List

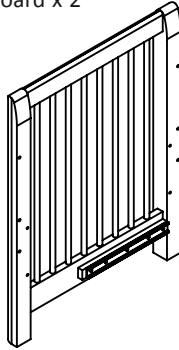
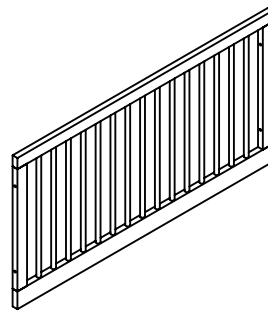
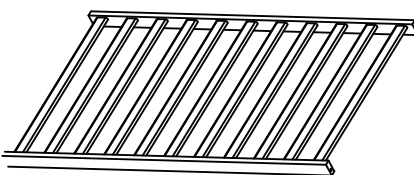
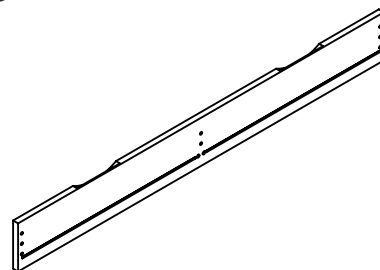
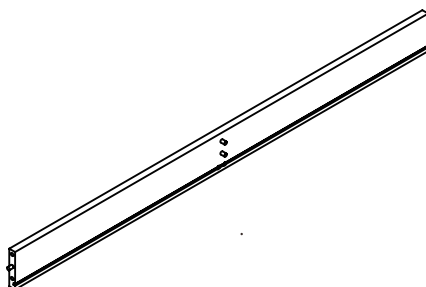
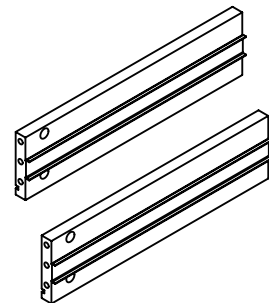
<p>A Headboard x 2</p> 	<p>B Side Panel x 2</p> 
<p>C Base x 1</p> 	<p>D Drawer Front Panel x 1</p> 
<p>E Drawer Rear Panel x 1</p> 	<p>F Drawer Side Panel x 2</p> 

Part List

G Drawer Support Rail x 1

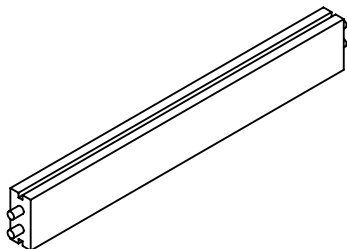

H Drawer Middle Panel x 1

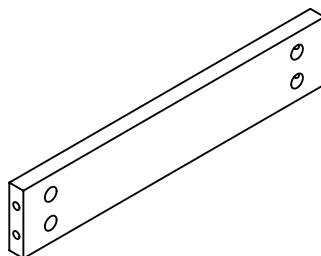

I Drawer Bottom Base x 2

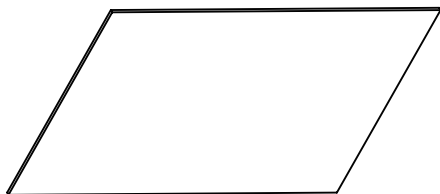

J Toddler Rail x 1

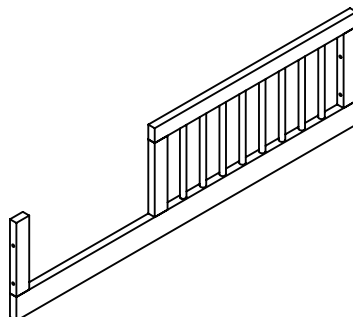

K M6 x 95mm Bolt x 4



L M6 x 65mm Bolt x 8



Part List

M M6 x50mm Bolt x 4



N Camlock x 12

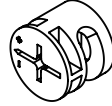

O Locking Pin x 12

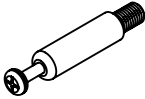

P M6 x 20mm Cap Screw x 4

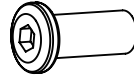

Q M6 x 22mm Metal Cross Dowel x 4

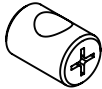

R M6 x15mm Bolt x 2

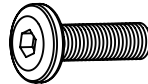

Part List

S Allen Key x 1



T Screw Drive x 1

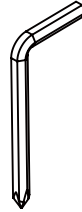

Drawer Assembly

Step 1: Fit locking pins to drawer side panels.

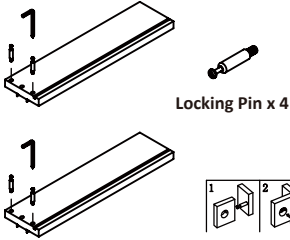

Fit camlocks to drawer rear panel.

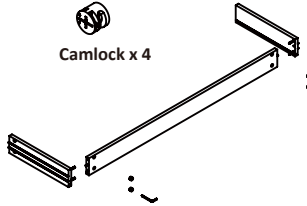

Fit locking pins to drawer back panel as shown.

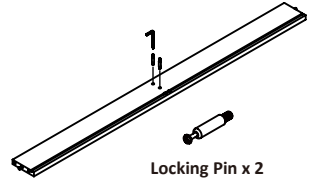

Step 2: Fit the drawer support rail onto the drawer rear panel.

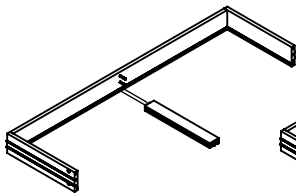

Fit the middle panel onto the drawer rear panel and secure with camlocks.

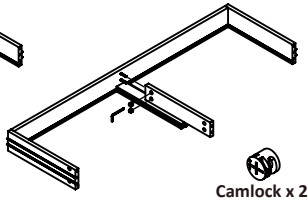

Insert the drawer base panel into grooves in the middle panel and the side panels.

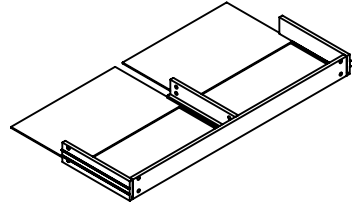

Step 3: Fit locking pins to drawer front panel.

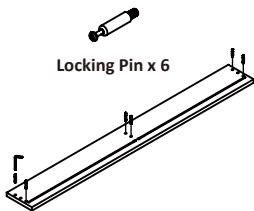

Fit drawer side panels to the drawer front panel secure with camlocks.

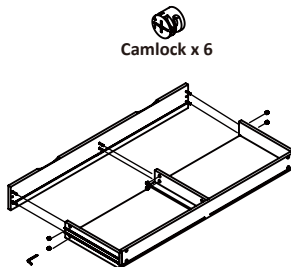

Now the drawer is completed

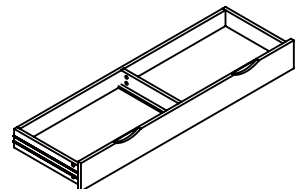

Cot Assembly

Step 1: Fit one headboard with one side panel secure with M6 x 65mm bolts.

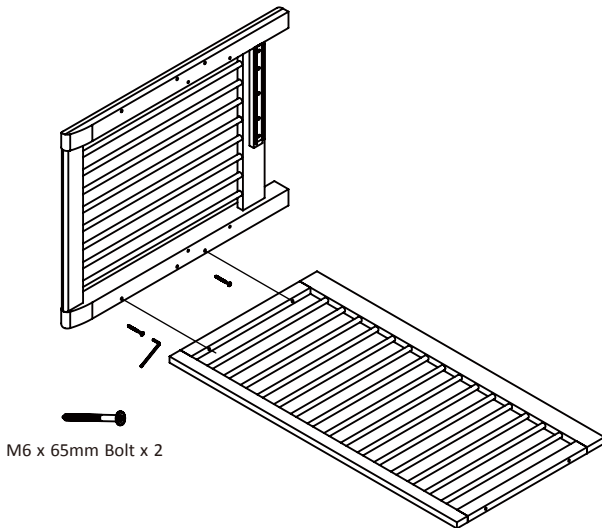

Step 2: Connect the base with headboard secure with M6 x 95mm bolts and metal cross dowels.

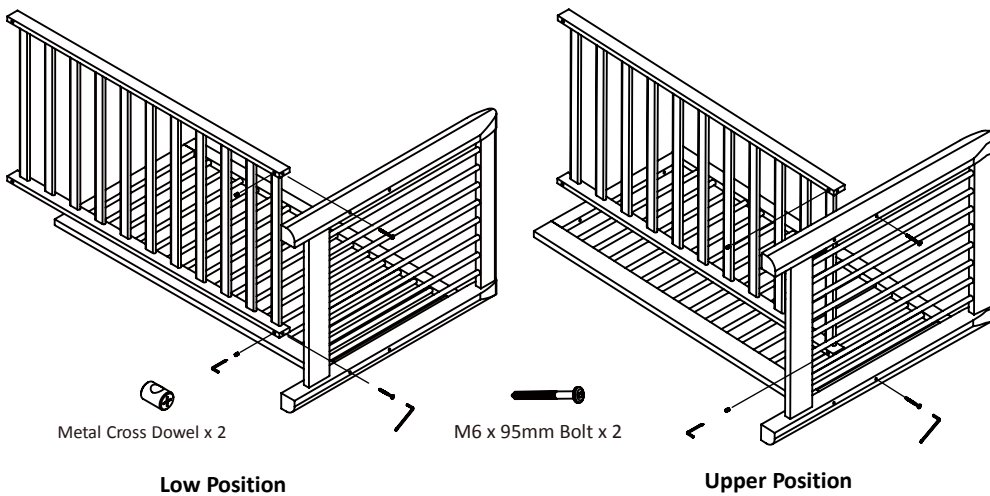

NOTE: The low position will be shown for the remaining instructions.

WARNING: To prevent falls, the mattress base of this cot should be adjusted to the lower position before the child can sit up.

Step 3: Connect other headboard with base and side panel secure with bolts and metal cross dowels.

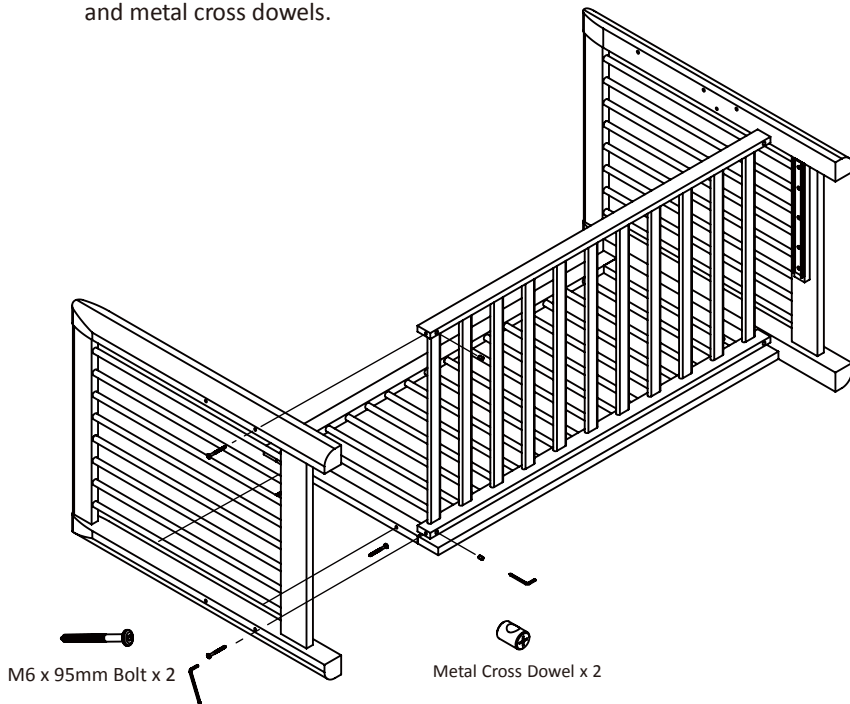

Step 4: Fit other side panel with two headboards secure with M6 x 65mm bolts.

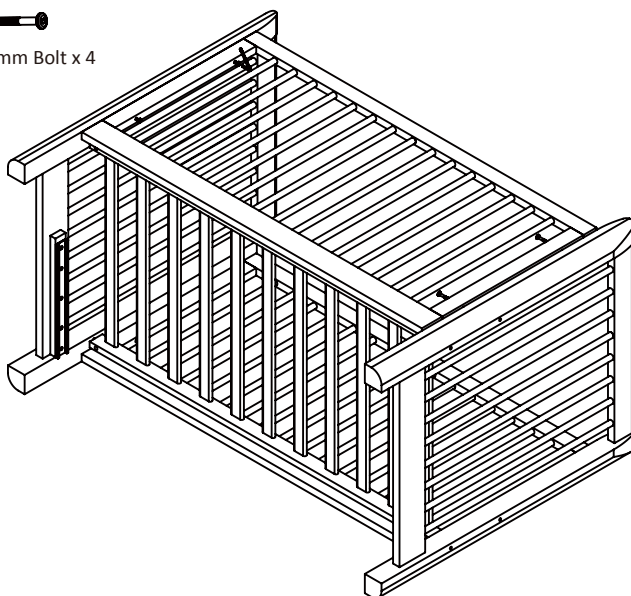

Step 5: Fix M6 x 50mm bolts and M6 x 20mm cap screws to unused holes.

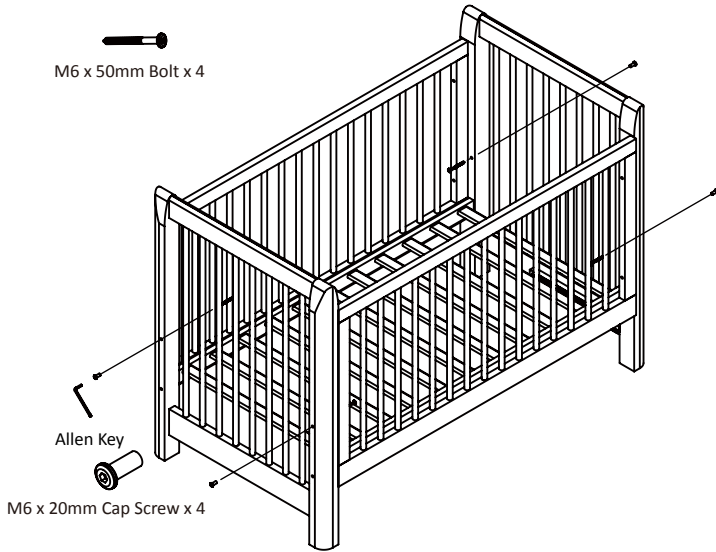

Step 6: Insert the runner on the drawer into runner fixed into frame of the headboard once aligned push drawer in. Check and tighten all the bolts and screws as required but take caution not to over tighten.

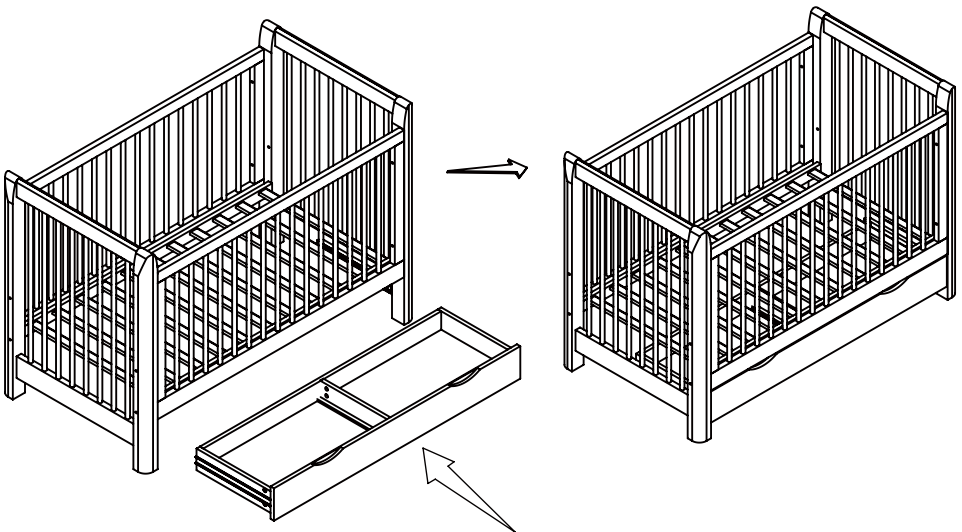

Convert To Toddler Bed Assembly

Step 1: Remove the bolts from the cot frame.

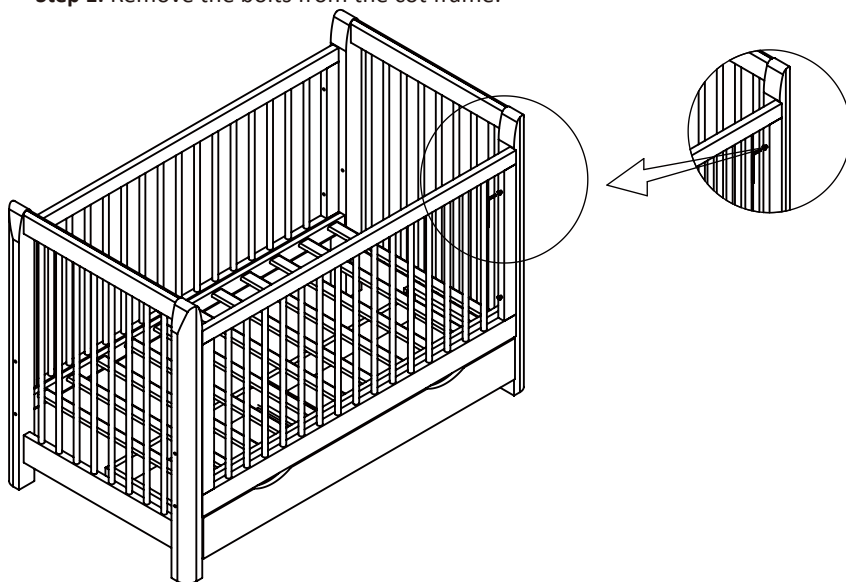

Step 2: Remove the side panel from the cot frame.

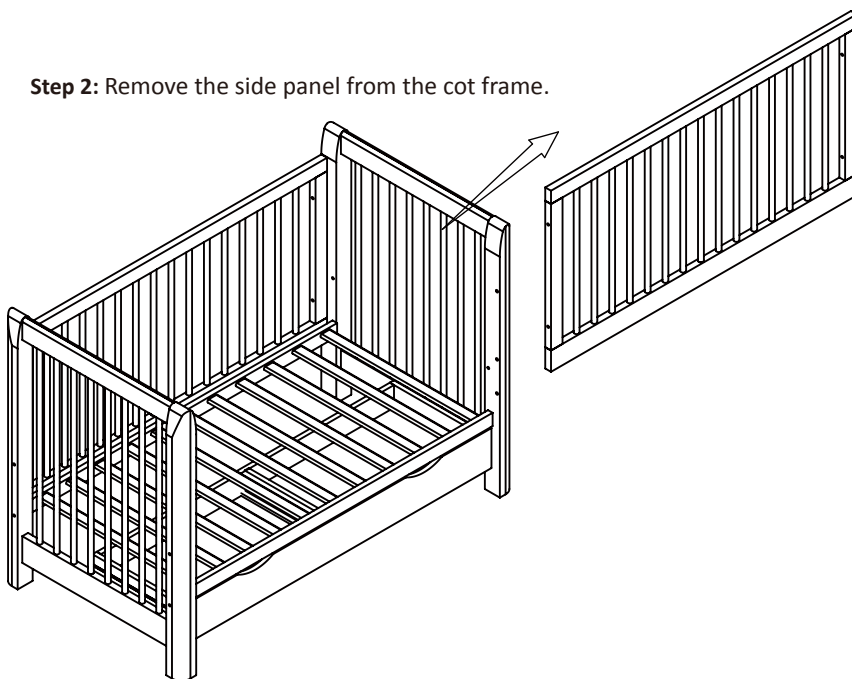

Step 3: Fit toddler rail with two side panels with M6 x 65mm bolts.



M6 x 65mm Bolt x 4

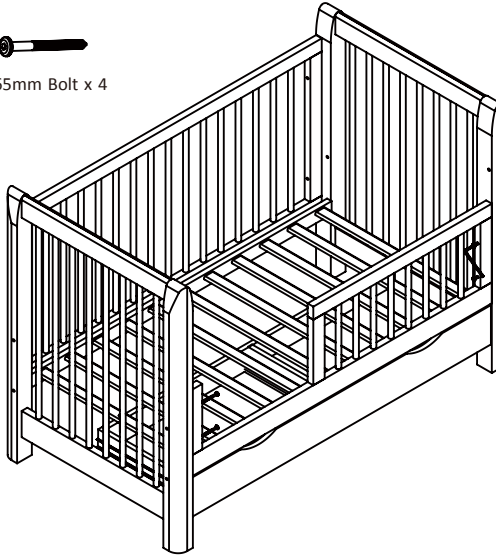

Step 4: Fix M6 x 15mm bolts to unused holes. Check and tighten all the bolts as required but take caution not to over tighten.



M6 x 15mm Bolt x 2

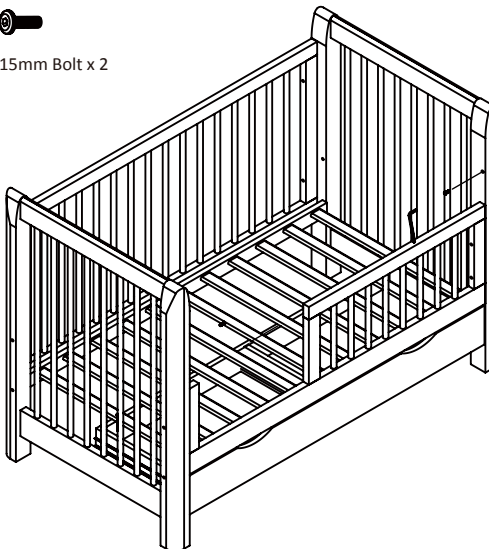

CARE AND MAINTENANCE

- Check cot regularly to ensure that locking devices and components are secure and working properly.
- Always check parts regularly for tightness of screws, nuts and other fasteners – tighten or replace if required.
- To maintain the safety of your cot, discontinue use and seek prompt repairs for bent, torn, worn or broken parts.
- Regularly inspect and maintain your product to ensure the freedom of movements of the locking devices and assembly fittings are tightened correctly.
- To prolong the life of your cot, keep it clean and do not leave it in direct sunlight for extended periods of time.
- Use a damp cloth to clean the frame.
- Do not use abrasive cleaners.

NOTE:

For general dusting / cleaning - periodically wipe the cot with a dry soft cloth. To remove day to day spills or dirt, wipe down with a soft cloth and mild solution of warm soapy water. Avoid scourers and steel wool as these will damage the finish. Always dry the cot after cleaning.

GROTiME

Grotime

110-114 Old Bathurst Road, Emu Plains, NSW 2750

Australia: 1300 92 4632 New Zealand: 067 590 870

www.grotime.com.au www.grotime.co.nz
