

Bassinet/Bedside Sleeper

MODEL 31110



INSTRUCTIONS/WARNINGS

IMPORTANT. RETAIN FOR FUTURE REFERENCE. READ CAREFULLY

SAFETY INSTRUCTIONS:

Before using this product, read these instructions in their entirety, for assistance contact Grotime customer care:

AU: 1300 92 4632

NZ: 067 590 870

NOTE: The illustrations displayed throughout this booklet are for demonstration only, product specifications are subject to change without notice. Assemble product according to manufacturers instructions for any mode - bedside sleeper as well as bassinet mode

CARE AND MAINTENANCE

- To prolong the life of your bassinet, keep it clean and do not leave in direct sunlight for extended periods of time.
- Do not use abrasive cleaners. Do not soak in water.
- Removable fabric covers and trims may be cleaned using warm water with a household soap or mild detergent. Allow it to dry fully, preferably away from direct sunlight.
- Always store your product in a clean dry place.
- Do not leave in the boot of a car
- Do not allow the product to come into contact with sand or salt water, sand causes corrosion and salt water the formation of rust.
- Do not dry clean or use bleach
- Do not machine wash, tumble or spin dry. Fabric and frame may be cleaned using a damp sponge with soap or mild detergent. The mattress can be washed by hand (see washing label). Allow to dry completely before folding or storing it away.
- In some climates, the covers and trims may be affected by mould and mildew. To help prevent this occurring, do not fold or store the product if it is damp, always store the product in a well ventilated area.
- To maintain the safety of your nursery product, seek prompt service for bent, torn, worn or broken parts.
- Use only those proved by the manufacturer.
- Always check parts regularly for tightness of screws, nuts and other fasteners - tighten if required.
- If the bassinet is not working correctly, stop using the high chair until repaired.
- DO NOT use bedside sleeper if any parts are missing, damaged, or broken. Contact Grotime for replacement parts and instructional literature if needed. DO NOT substitute parts.

⚠️ WARNING ⚠️ – FAILURE TO FOLLOW THESE WARNINGS AND THE INSTRUCTIONS COULD RESULT IN SERIOUS INJURY OR DEATH.

FALL HAZARD — To help prevent falls, do not use this product when the infant begins to push up on hands and knees or has reached 9kg, whichever comes first.

SUFFOCATION HAZARD:

Infants have suffocated:

- In gaps between extra padding and side of bassinet/cradle, and
- On soft bedding
- Use only the pad provided by the manufacturer. **NEVER** add a pillow, comforter, or another mattress for padding.
- To reduce the risk of SIDS, paediatricians recommend healthy infants be placed on their backs to sleep, unless otherwise advised by your physician.
- If a sheet is used with the pad, use only the one provided by the bassinet or cradle manufacturer or one specifically designed to fit the dimension of the bassinet or cradle mattress.

WARNING! – Strings can cause strangulation! Do not place items with a string around a child's neck, such as hood strings or pacifier cords. Do not suspend strings over a bassinet or cradle or attach strings to toys.

CONTENTS:

Before using this product remove and check all components within the packaging for scratches or dents.

- A: Bassinet Frame & Cover (Folded inside Carton) (x 1)
- B: Bassinet Frame (x 1)
- C: Leg Joint (x 1)
- D: Left Leg (x 1)
- E: Right Leg (x 1)



ASSEMBLY - BASSINET MODE

The improper assembly of this product can lead to serious injury of your child. Ensure that the 31110 is assembled as per these instructions.

WARNING:

Please keep all packaging material away from the babies and children to prevent suffocation.

Step 1. Unpack Contents.

Step 2. Take out Left Leg (D) refer (Figure 2A) and untie the rope from the leg (Figure 2B).



Figure 2A



Figure 2B

ASSEMBLY - BASSINET MODE

Step 3.

Press the button on the Left Leg (D) to then connect the Leg Joint (C) (refer Figure 3A). Ensure the button pushes back through the joint when connected.

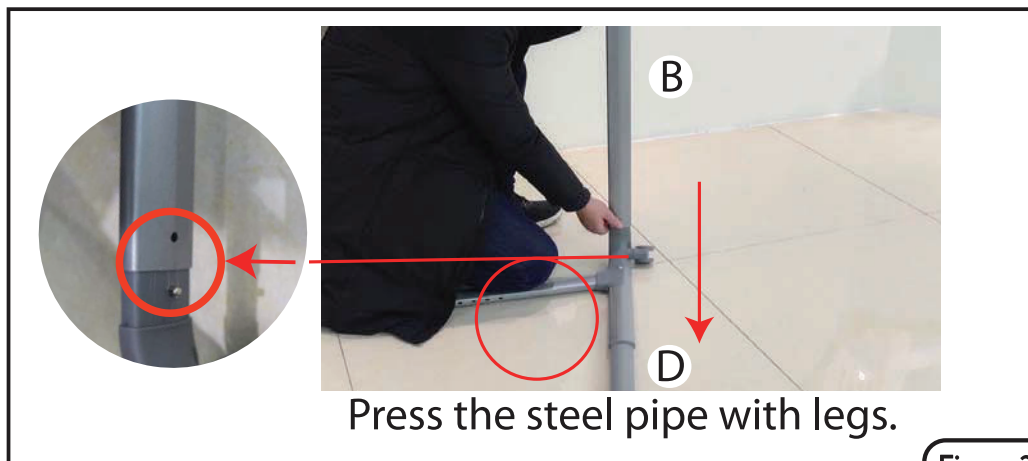

Figure 3A

Step 4.

Repeat Step 2 and 3 with the Right Leg (E).

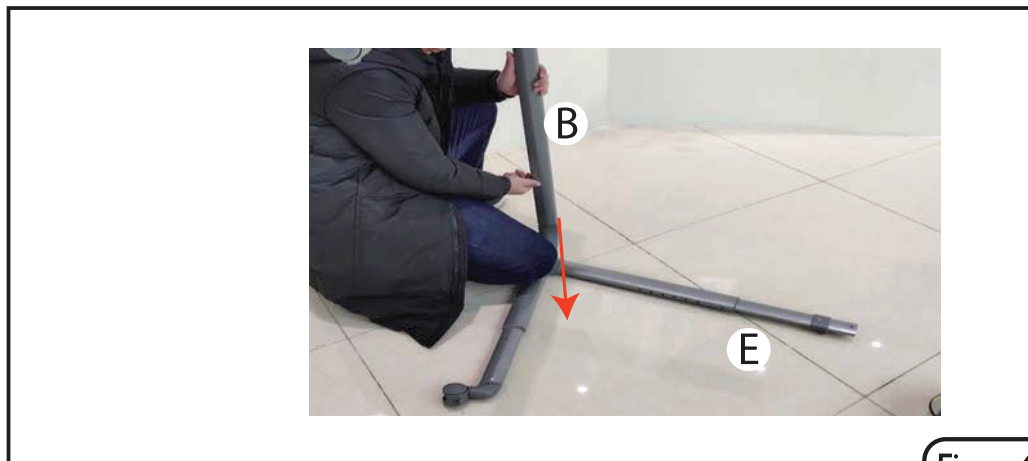

Figure 4A

ASSEMBLY - BASSINET MODE

Step 5. You have now completed the assembly of the lower frame for your 31110 bedside sleeper.



Figure 5A

Step 6. Insert both Legs into the upper bassinet frame, one at a time. (refer Figures 6A-6D).



Figure 6A



Figure 6B



Figure 6C



Figure 6D

ASSEMBLY - BASSINET MODE

Step 7. Unzip the zipper on the bassinet's cloth cover (refer Figures 7A & 7B).



Figure 7A



Figure 7B

Step 8. Press the spring pin down and clip the bassinet into the groove (refer Figures 8A-8D).

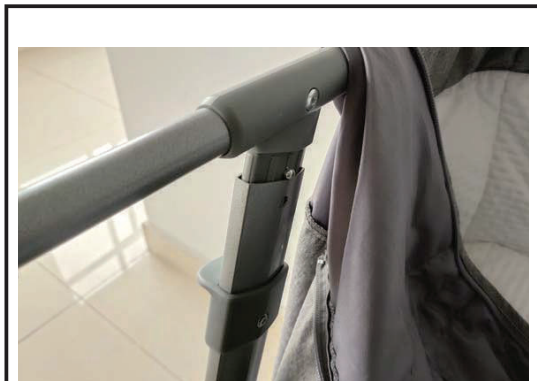

Figure 8A



Figure 8B



Figure 8C



Figure 8D

ASSEMBLY - BASSINET MODE

Step 9.

Press the spring lock down at the bottom of the bassinet and insert the Bassinet Frame (B) into the slot as seen in Figure 9A & 9B.



Figure 9A



Figure 9B

Repeat this step for the other side of frame and then cover the Bassinet Frame as seen in Figure 9C. Then seal cover by using the 2 velcro straps (refer Figure 9D & 9E).

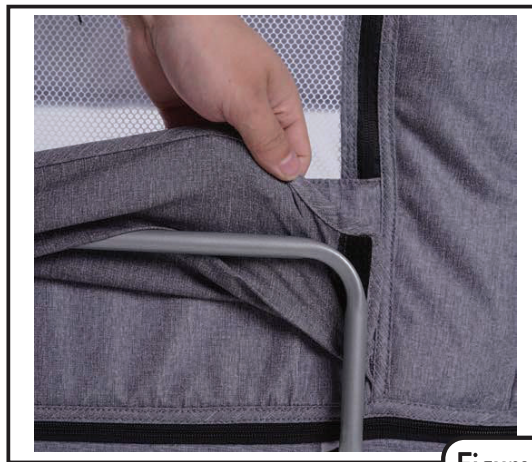

Figure 9C

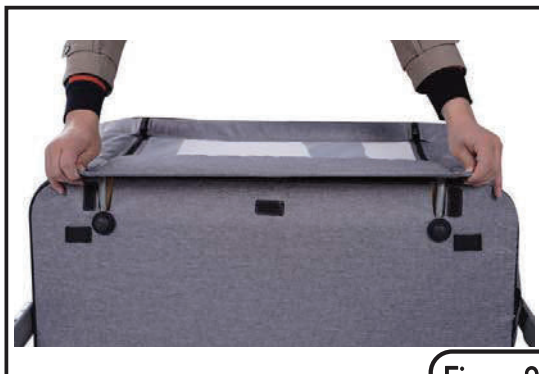

Figure 9D

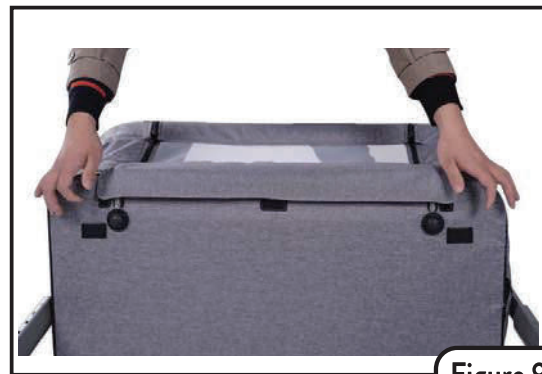

Figure 9E

ASSEMBLED BASSINET

- See reference below for your assembled 31110 bassinet.



USE

Lift Function

Pull the handles on both sides to adjust the height of the bassinet (Can be adjusted up and down).

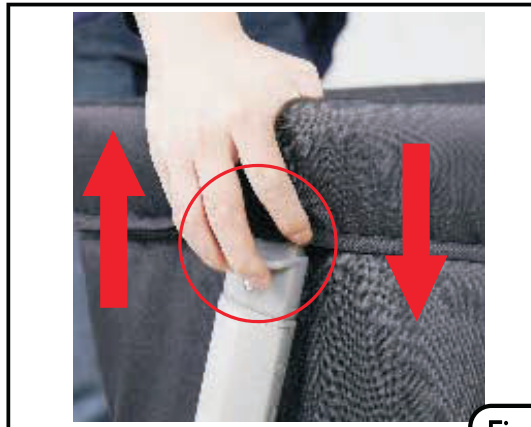

Figure 10

Lock Castors

The bassinet is fitted with castor wheels for mobility. The wheels are lockable to ensure stability of the bassinet.

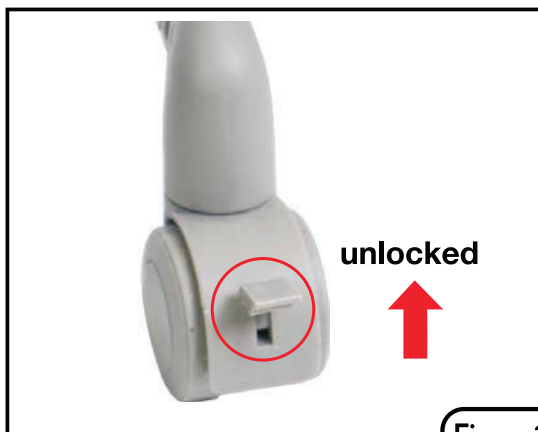

Figure 11A

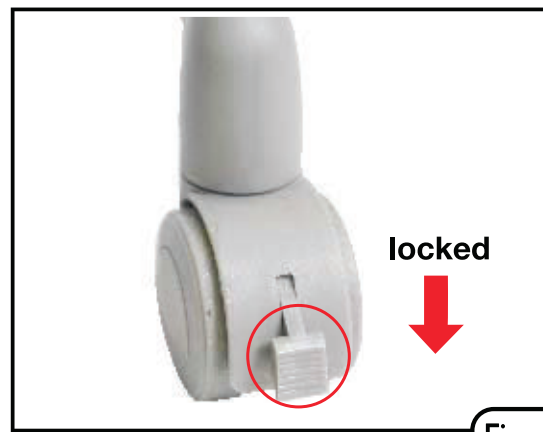

Figure 11B

⚠️ WARNING ⚠️ • FAILURE TO FOLLOW THESE WARNINGS AND THE INSTRUCTIONS COULD RESULT IN SERIOUS INJURY OR DEATH.

This bedside sleeper is designed for use only with adult beds that are between 50cm and 67cm's from the floor to top of adult mattress.

A bedside sleeper is designed to provide a sleeping area for an infant until he or she begins to push up on hands and knees, or approximately 5 months of age. Move your child to another sleeping product when your child reaches this stage.

Entrapment Hazard • To prevent death from entrapment, bedside sleeper must be properly secured to adult bed using the attachment system.

- 1) There must be no more than 13mm gap between bedside sleeper and adult bed.
- 2) Check tightness before each use by pulling bedside sleeper in a direction away from adult bed.
- 3) If the gap exceeds 13mm, **DO NOT** use product.

Do not fill the gap with pillows, blankets or other items that are suffocation hazards. Always read and follow assembly instructions for each product use mode (bedside sleeper, bassinet, play yard).

Always use ALL required parts. Periodically check for loose, damaged, or missing parts.

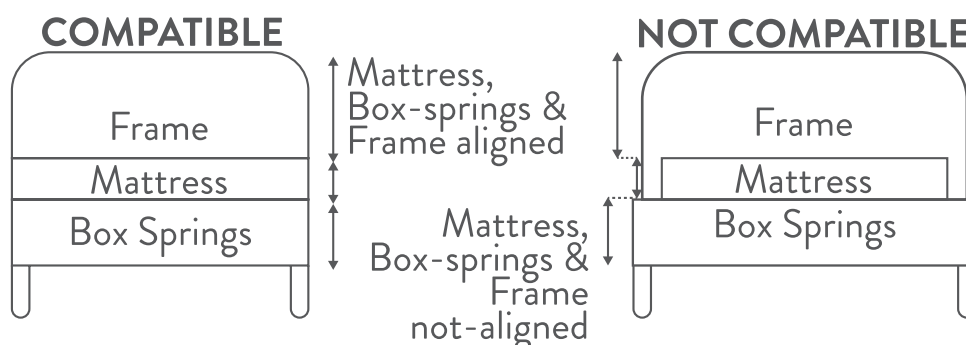

To avoid death from infants' neck being caught on top rail on the side that is next to the adult bed, the top rail must be no higher than the adult bed mattress.

ASSEMBLY - BEDSIDE SLEEPER MODE

Step 1.

First unzip the bassinet then push the spring lock in the opposite direction and finally remove the tube from the bassinet.



Figure 12A



Figure 12B



Figure 12C



Figure 12D

ASSEMBLY - BEDSIDE SLEEPER MODE

Step 1.

Take out the connecting strap and pass the buckle through the ribbon to connect the mother buckle under the bassinet.



Figure 13

Step 2.

The other ribbon is connected in the same way.



Figure 14

ASSEMBLY - BEDSIDE SLEEPER MODE

Step 3.

Unlock the safety buckle, pass the connecting strap under the mattress and buckle back the safety buckle to tighten the mattress.



Figure 15A



Figure 15B

After fixing the bassinet, please try to push the bassinet to ensure that the gap between the bassinet and the adult bed does not exceed 13mm, if it is more than 13mm re-adjust the adjustable buckle on the connecting belt. The four Castor wheels of the bassinet need to be locked during use. Before using the bassinet, please roll up the extra connecting belt and fix it. Before using the bassinet, please check whether the connecting belt has been tightened.

IMPORTANT:

When the bassinet is connected to the adult bed, the lifting rail of the bassinet must be at the lowest position, and the height shall be lower than the adult bed to avoid the baby falling off the bassinet.

ASSEMBLY - BEDSIDE SLEEPER MODE

Step 4.

Your 31110 is now setup for its bedside sleeper mode see below for reference.

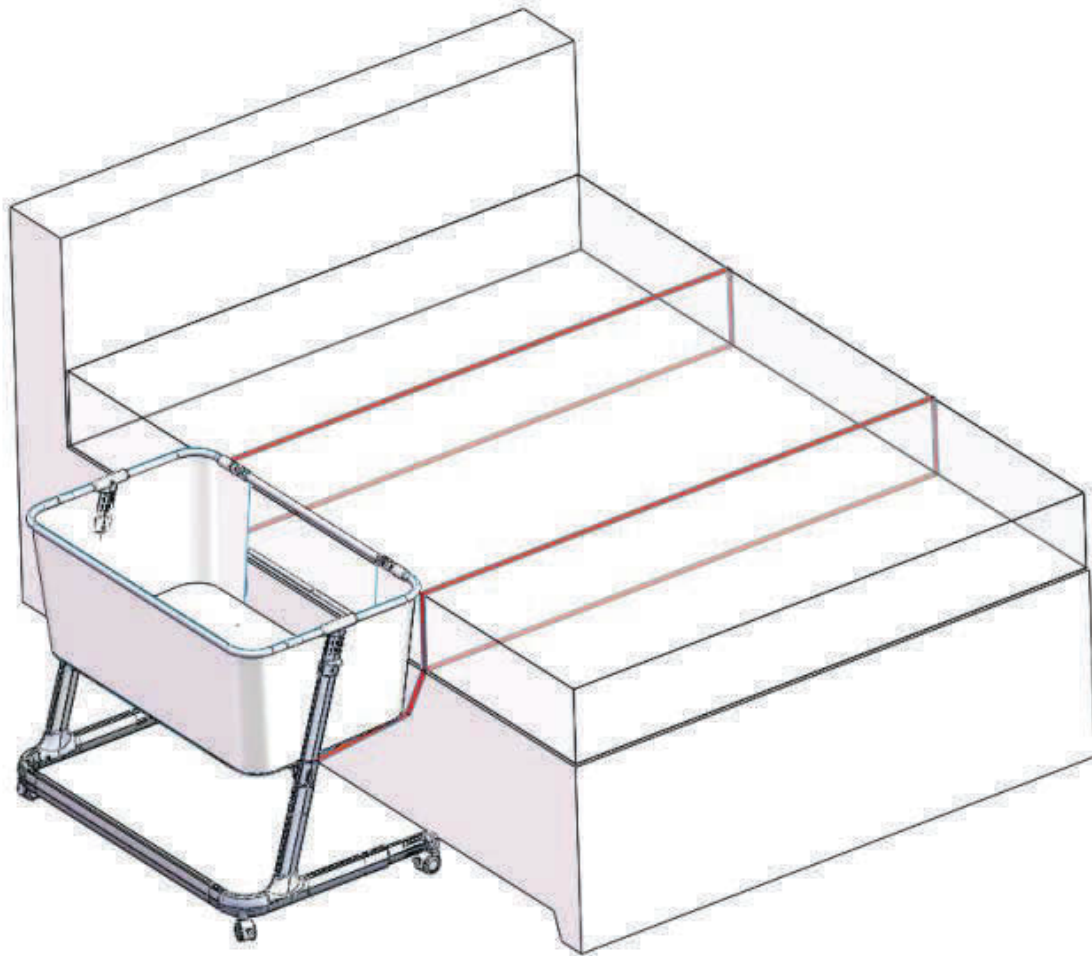

WARRANTY

Grotime Pty Ltd warrants this product for twelve months from the date of purchase against failure due to manufacturing faults or faulty materials. Misuse, accidental damages, normal wear and tear are not covered by this warranty. When used for commercial use this period is limited to six months. “Our goods come with guarantees that cannot be excluded under the Australian Consumer Law. You are entitled to a replacement or refund for a major failure and for compensation for any other foreseeable loss or damage. You are also entitled to have the goods repaired or replaced if the goods fail to be of acceptable quality and the failure does not amount to a major failure.

STORAGE:

To store your Bassinet/Bedside Sleeper (31110), please reverse assembly steps. Ensure all components are kept together along with Instruction manual for future use.

**KEEP BOOKLET FOR FUTURE REFERENCE
READ ALL INSTRUCTIONS CAREFULLY BEFORE USE OF THIS
BASSINET. ALWAYS FOLLOW THE INSTRUCTIONS. THE CORRECT USE
AND MAINTENANCE OF THIS PRODUCT IS ESSENTIAL.**

THIS PRODUCT IS NOT INTENDED FOR COMMERCIAL USE.

www.grotime.com.au
www.grotime.co.nz

GROTIME
ABN: 52 149 173 660
110-114 Old Bathurst Rd,
Emu Plains, NSW 2750

CUSTOMER CARE
AU: 1300 92 4632
NZ: 067 590 870
Email: customercare@infa.com.au

MADE IN CHINA
MODEL NO: 31110
ISSUE B