

# Secure Safe

## INFA GROUP

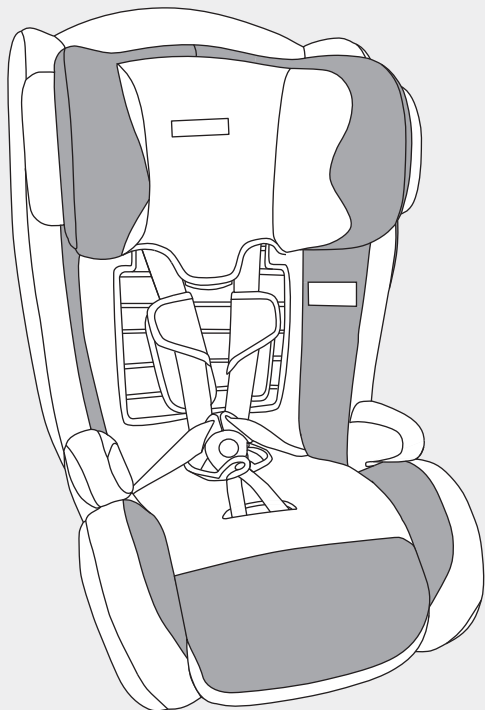

CS9513

SUITABLE FROM SIX MONTHS TO EIGHT YEARS\*

### CHILD CAR SEAT

(Forward Facing) Suitable for children from approximately 6 months to 8 years\* of age.

## Instruction Manual

**IMPORTANT: KEEP THIS BOOKLET IN THE PLACE PROVIDED ON THE CHILD RESTRAINT**

\*All references to age are approximates only and reference to children of average proportions. Children vary in shapes and sizes. The photo displayed is indicative of the type of restraint and may vary slightly depending on the model.



**Australian  
Standard**

AS/NZS: 1754:2013  
Licence No. 25324-1  
SAI Global

Forward Facing Mode (Use For Child)

## SLOT SELECTION

REFER TO PAGES 15 - 17

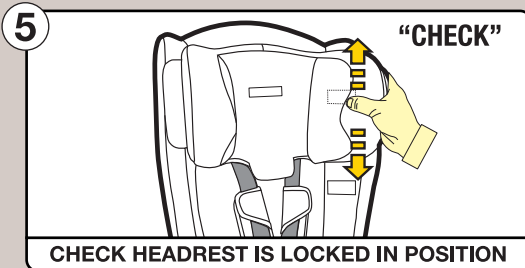
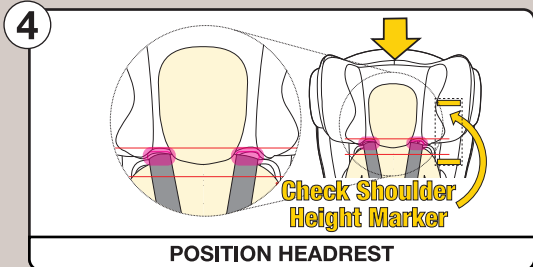
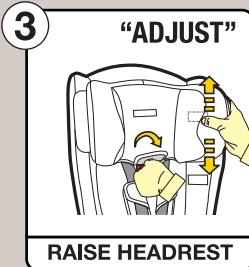
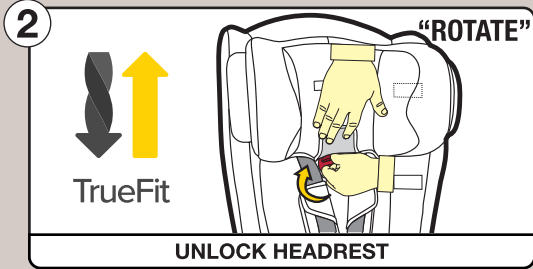
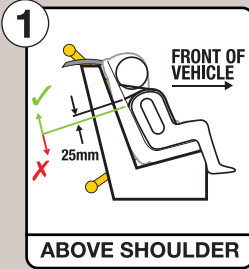

## Forward Facing Mode (Use For Child)

### INSTALLATION

REFER TO PAGES 19 - 24

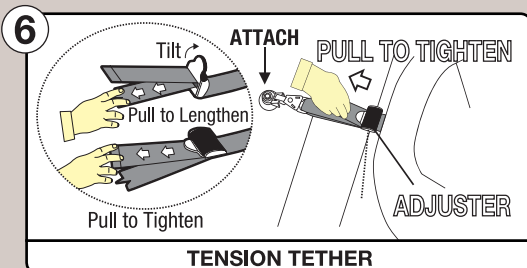
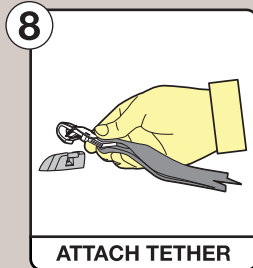
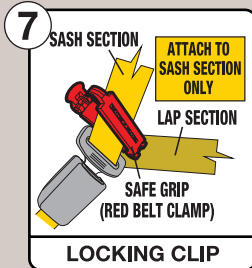
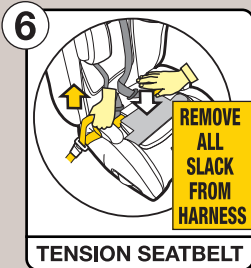
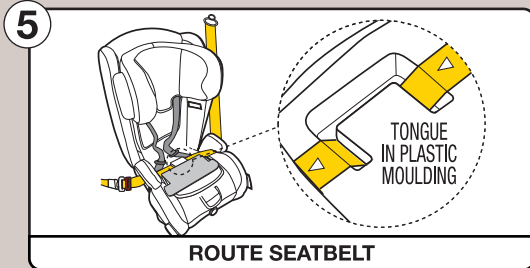
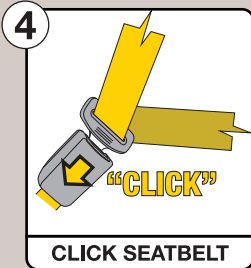
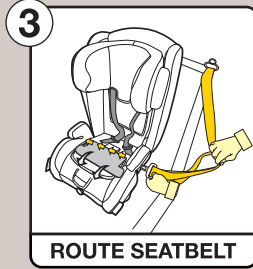
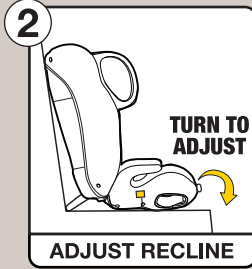
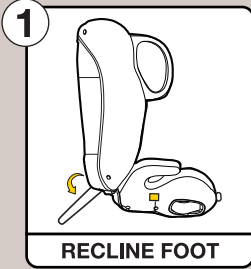

## Forward Facing Mode (Use For Child)

### USE

REFER TO PAGES 25 - 27

**1**

**PULL TO LENGTHEN**   **PULL TO LENGTHEN**

HARNESS ADJUSTER  
"LIFT" TO LENGTHEN

**LOOSEN HARNESS**

**2**

**Check Shoulder Height Marker**

**CHECK HEADREST / SLOT POSITION**

**3**

**POSITION CHILD AND CLIP BUCKLE**

**4**

**REMOVE ALL SLACK FROM HARNESS**  
"PULL" TO TIGHTEN

**TENSION HARNESS**

**5**

**PINCH TEST**

**PINCH TEST**

# Contents

Contents	1
Information	2
Warnings	5
Restraint Guide	7
Padding - Combination Guide	8
<b>Child Car Seat</b>	
- Information	9
- Shoulder Height Markers	10
- CS9513 Child Restraints (Itemised List)	12
- Next Restraint	13
Setup	
- Adjusting Recline Angle	14
- Shoulder Height	15
- Headrest & Harness Strap Height Adjustment	16
- Buckle Height Adjustment	18
Installation	
- Installing Using Vehicle Seatbelt	20
- Alternative Installation	22
- Installing Using Top Tether Strap	23
Use	
- Using Inbuilt Harness	25
- To Release Child	27
Care of Restraint	
- Care and Maintenance	28
- Cleaning	29
• Covers	29
• Seat + Hardware	29
• Harness Straps	29
• Harness Buckle	30
Remove Covers	
• Headrest	33
• Apron	33
• Backrest	33
• Seatbase	34
Replace Covers	
• Headrest	35
• Apron	35
• Seatbase	35
• Backrest	36
Extension Straps	36
Accessories	37
Anchorage Fittings	40
Insurers Information	42
Lifetime Warranty	43

Please read carefully the whole of the instructions for installation and, in the event of doubt about the method of installation, to consult SecureSafe or agent, or a child restraint fitter, or in New Zealand, to consult the agent for the vehicle.

# Information

This instruction manual covers various models under the Model number CS9513 design. These child restraints are installed in the rear of the car and can only be used forward-facing. They are installed in the car using the car seatbelt and the top tether strap attached to the car's child restraint anchor fitting. This Car Seat is designed to be used by children from approximately 6 months of age up to approximately 8 years of age.

## **Infa Group**

Infa Group is a family owned and operated business located in Sydney, Australia. With over 65 Years experience in Juvenile Products, our mission is to deliver Safety and Innovation.

Infa Group strives to create a real difference for our customers. We design and manufacture safe, stylish and affordable Child Restraints and Nursery products. All products are engineered to a high quality and standard so that your young ones will be secure in an Infa Group product.

## **Child Restraints**

No child restraint can guarantee absolute protection from injury in every crash. However, to ensure that your child gets all the protection designed into the restraint please read and follow the instructions exactly and use only SecureSafe recommended parts and accessories.



# Information

## **Protect Plus**

*Protect Plus is a family of safety technologies, designed to work in unison to protect your child in the event of an accident.*

### **Armour Tech**

Armour Tech is the foundation of our Protect Plus System. It is a layer of air held within the entirety of the child restraint shell. This cocoon of air provides an increased level of protection across the entire surface area of the restraint, which compliments and elevates the performance of *Side Impact Pod* and *Active Air Pad*.

### **Side Impact Pod**

Side Impact Pod is a safety technology integrated directly into the child restraint headrest. It is designed to offer superior structural integrity, advanced impact management, and optimal positioning of your child's head in the event of an accident. It adds additional air cushioning between your child's head and the impact point, keeping them as far from harm as possible.

### **Active Air Pad**

Active Air Pad adds a third, soft layer of protection to your child. It cushions the head, gently expelling air before the 8 shock absorbing domes further dissipate crash forces. In conjunction with Armour Tech, Active Air Pad reduces crash energy to well below the requirements of the Australian Standard.



# PROTECT PLUS

Complete Safety System



## Armour Tech

Advanced Torso Protection



## Side Impact Pod

Advanced Impact Management



## Active Air Pad

Advanced Head Protection

# Information

## TrueFit

TrueFit allows one-handed adjustment of the headrest and harness from the front of the restraint. No re-threading straps, no uninstalling - you can get the perfect fit in seconds, and it's never been easier



**TrueFit**

Harness Adjustment System

## Advanced Contour Cover

The Advanced Contour Cover provides ultimate airflow around your child and the highest degrees of comfort.



**Advanced Contour Cover**

Ultimate airflow and comfort



# Warnings



## WARNINGS

- Use the restraint exactly as shown in the instructions.
- Supervision of children is needed because they may be able to undo buckles.
- **DO NOT LEAVE CHILDREN UNATTENDED IN THE CAR.**
- Do not alter or modify this restraint.
- Repairs must only be done by the manufacturers or agent.
- Do not allow the restraint to come into contact with polishes, oils, bleach and other chemicals.
- Destroy the restraint if it has been in a severe crash, even if no damage is visible.
- **DO NOT USE THIS RESTRAINT WITHOUT THE COVER.**
- Fit the restraint firmly to the car seat.
- Fit the harness firmly to the child.
- A loose restraint or harness is dangerous.
- Always secure the loose end of the top tether strap. Do not use the child restraint where this strap may fall into a split in the seat back or off the side of the seat.
- **ALWAYS ATTACH HOOK AND REMOVE SLACK**
- **DO NOT ATTACH THIS CHILD RESTRAINT TO ANY ISOFIX LOW ANCHORAGE.** ISOFIX low anchorages in cars are designed to withstand only those loads imposed by children aged up to approximately 4 years of age in a correctly fitted and approved ISOFIX compatible child restraint. This child restraint is not approved for use with the car's ISOFIX low anchorages.

Please read carefully the whole of the instructions for installation and, in the event of doubt about the method of installation, to consult SecureSafe or agent, or a child restraint fitter, or in New Zealand, to consult the agent for the vehicle.

# Warnings



## **WARNINGS**

- THIS RESTRAINT IS NOT SUITABLE FOR USE WHERE THE TOP TETHER STRAP MAY FALL INTO A SPLIT IN THE SEAT BACK OR OFF THE SIDE OF THE SEAT.
- THIS RESTRAINT MUST BE ATTACHED TO A CHILD RESTRAINT UPPER ANCHORAGE POINT IN THE CAR. REFER TO CAR OWNER'S HANDBOOK FOR LOCATION OF ANCHORAGE POINTS. REFER TO A CHILD RESTRAINT FITTING STATION IF NO ANCHORAGE POINTS ARE IN THE MOTOR CAR.
- Always secure the loose end of the top tether strap to prevent it hanging out of the car or being accessible by the child. Do not use the child restraint where this strap may fall into a split into the seat back or off the side of the seat.
- IF AN AIRBAG IS FITTED IN THE SEATING POSITION WHERE THE CHILD RESTRAINT IS TO BE FITTED, FOLLOW THE VEHICLE MANUFACTURER'S WARNINGS AND INSTRUCTIONS.
- THIS CHILD RESTRAINT IS NOT APPROVED FOR USE WITH ANY CONNECTORS THAT CONNECT TO THE CARS ISOFIX LOW ANCHORAGES.



## **WARNING**

**DO NOT LEAVE CHILDREN UNATTENDED IN THE CAR.**

# Restraint Guide

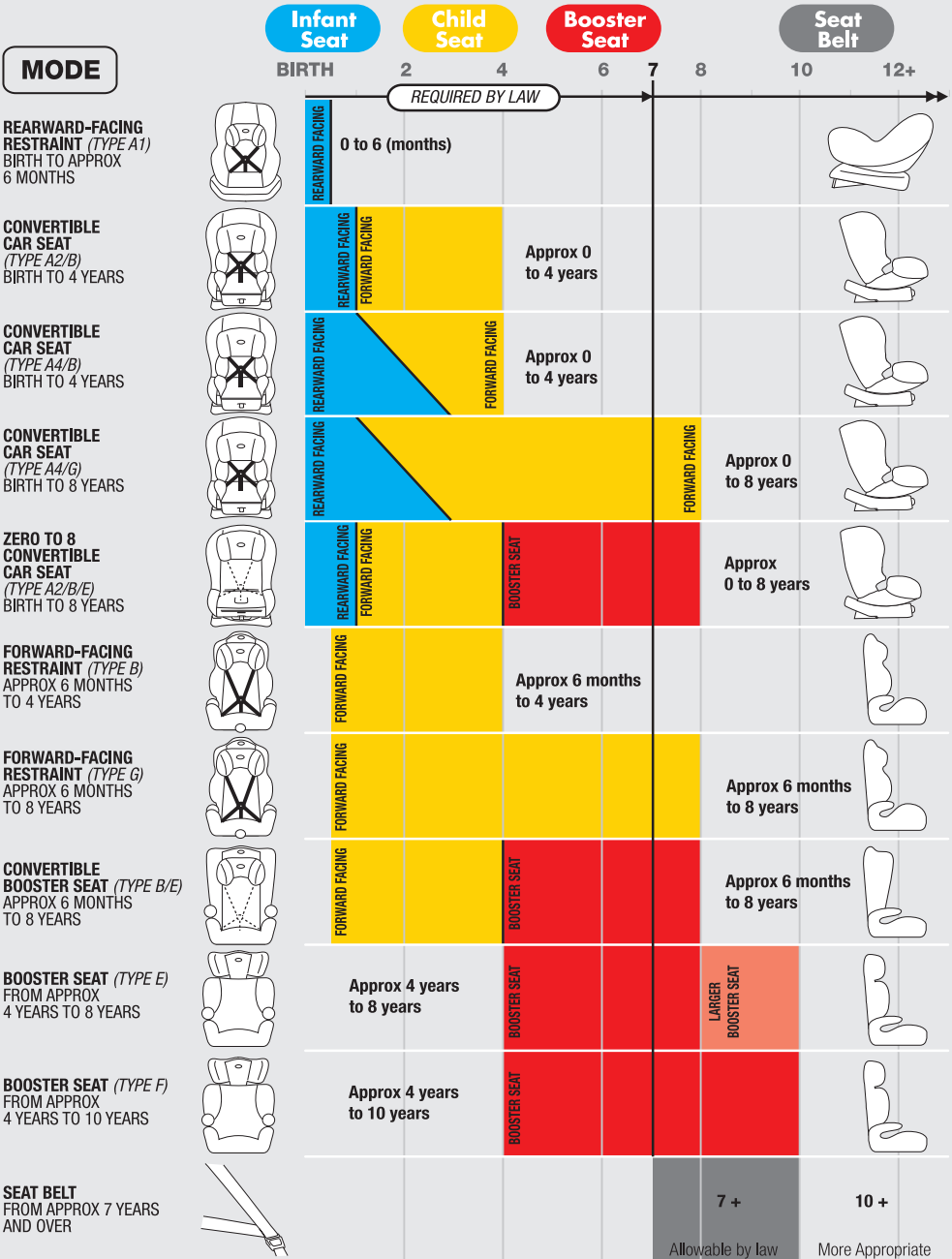

**IMPORTANT:** Research has shown that the likelihood of an accessory child safety harness being used incorrectly is very high and the risk of injuries when incorrectly used is much higher compared to a lap-sash seat belt. SecureSeat recommend that an accessory child safety harness should only be used if a lap-only seat belt is all that is available.

# Padding / Inserts

## Combination Guide

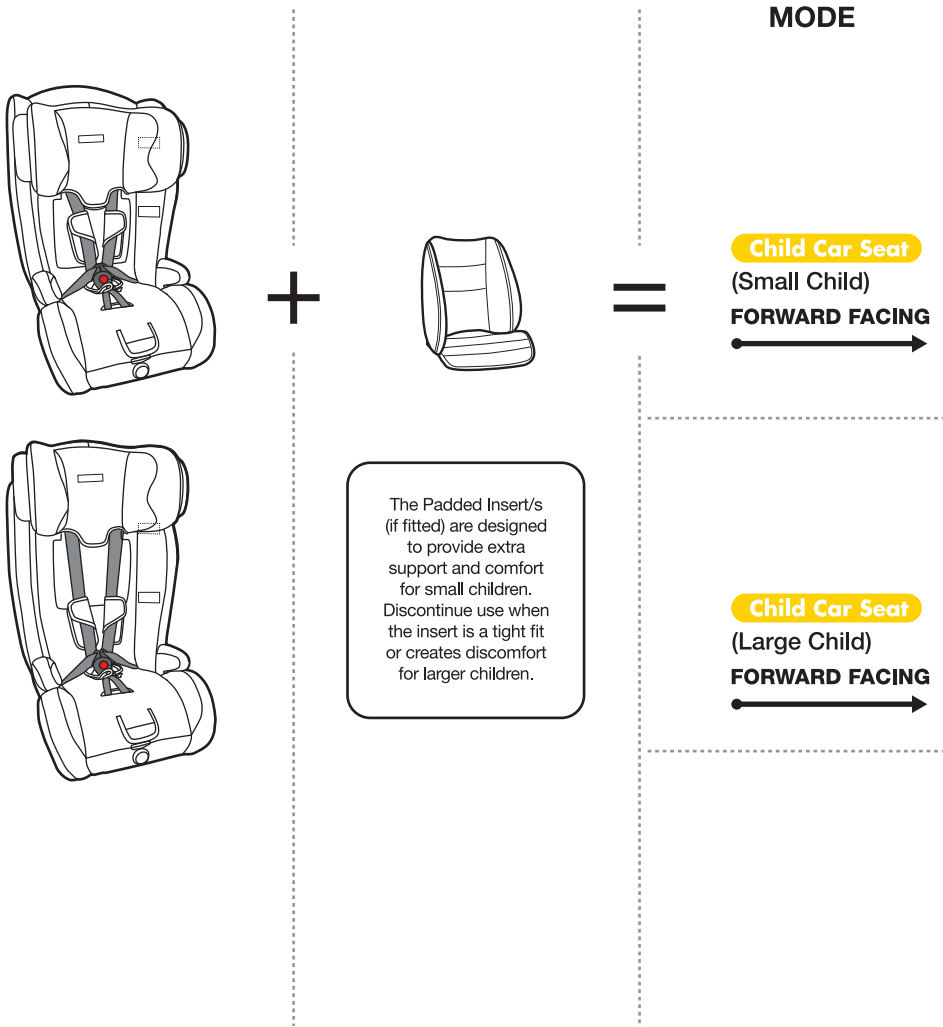

- \*Diagrams are indicative of type of paddings and inserts and may not resemble the actual product.
- \*Padded inserts can vary according to model (If supplied).
- We reserve the right to alter this product without notice.

\*For detailed description and method of attachment for padded accessories refer to Accessories on pages 36-38.

### THE SUITABILITY OF THE CHILD RESTRAINT TO GROUPS OF CHILDREN

#### TYPE G

To be used only in a forward-facing position by a child whose shoulders are above the lower shoulder height marker (approximately 6 months of age) until the child's shoulders reach the upper shoulder height marker (approximately 8 years of age).

Continue to use this child restraint until the child reaches this limit.

Do not use this child restraint until the child's shoulders are above the lower shoulder height marker.

Infants are at risk of serious injury if they face forward too early.

Children are at risk of serious injury if they move to booster seats too early.

Just using a seatbelt is not recommended for children that have out grown this restraint. Children are safest in a booster seat until their shoulders reach the upper shoulder height marker of the booster seat.

### **IMPORTANT**

- This restraint does not require the straps to be disconnected to adjust their height. Only the headrest needs to be moved to adjust the shoulder straps.
- This can be achieved without the restraint having to be removed from the car.

**TO BE USED WITH A LAP-SASH/LAP-ONLY SEAT BELT IN THE BACK OF MOST CARS WITH FORWARD FACING SEATS.**

The use of child restraints in the front seat may be restricted for children of specific ages by local legislation. Please check with your local Department of Transport for the specific seating locations of children using child restraints for their given ages.

### **IMPORTANT**

- For a vehicle without a fixed parcel shelf an extension strap(s) may be needed. If so ring 1300 92 4632 (AU) or 067 590 870 (NZ) for nearest supply location (refer page 35).
- Seatbelt extenders are not recommended to be used if the seatbelt is not long enough to secure the child restraint. If seatbelts are too short then advice should be sought from a child restraint fitter and their recommendation be considered before using a seatbelt extender.

For use in other countries other than Australia and New Zealand

- The child restraint may not be accepted for use in cars.

- Consult the country's local authorities, car hire companies, car insurance companies, etc. for advice.

# Shoulder Height Markers

Child Car Seat

Forward Facing

## Smaller Child (Using Inbuilt Harness)

Shoulder height markers are provided on this restraint for a visual indication that the child is safe to travel in this restraint.

*Shoulder height markers may be hidden under a headrest in the lowest position.*

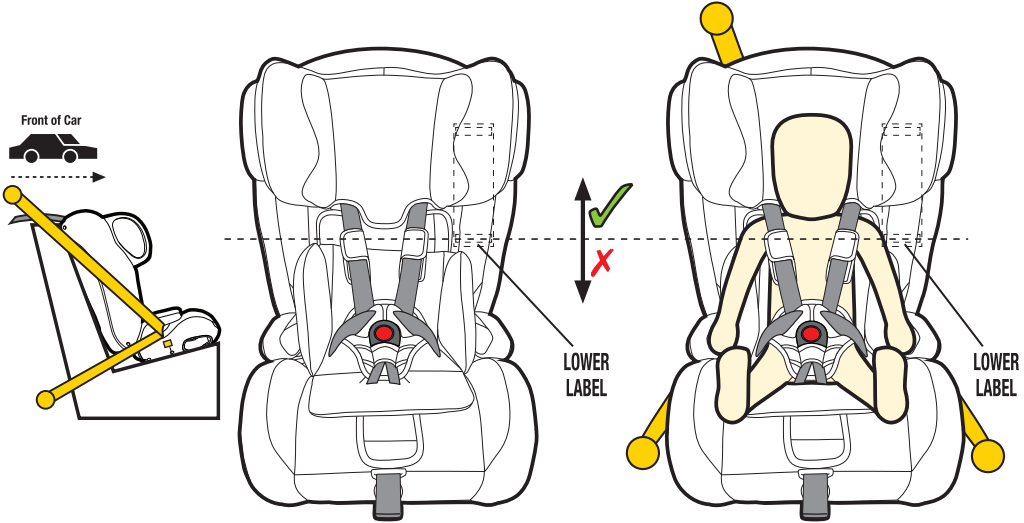

**Smaller Child from approximately 6 months of age**

Do not use a forward-facing child restraint until the child's shoulders are **ABOVE** the lower shoulder height marker (lower label).

LOWER LABEL

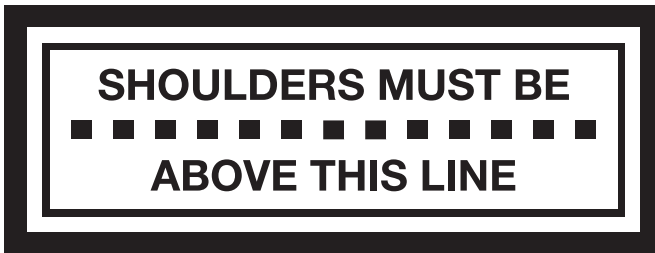

**! IMPORTANT**

When using the inbuilt harness the child's shoulders must be in-line or above this marker

If moving a child from rearward-facing child restraint, to forward facing child restraint the child's shoulders will need to be in-line or above the lower label. If the child's shoulders are below the lower label or if the baby's neck muscles are unable to support their head, then the child should remain rearward-facing.

### Taller Child (Using Inbuilt Harness)

*Shoulder height markers may be hidden under a headrest in the lowest position*

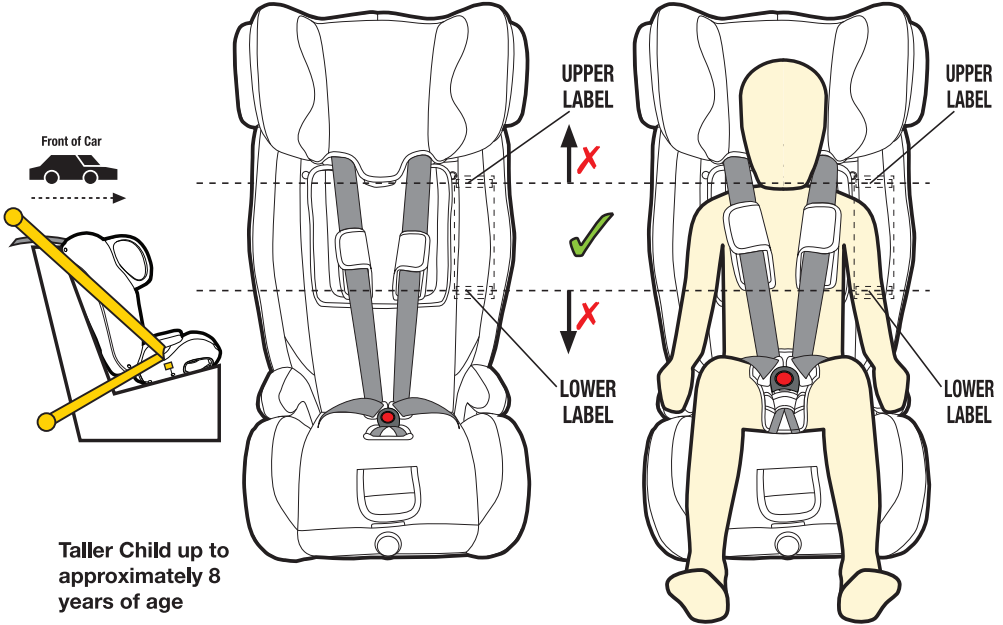

**Taller Child up to approximately 8 years of age**

Continue to use this forward-facing child restraint until the child's shoulders **REACH** the Upper shoulder height marker.

UPPER LABEL

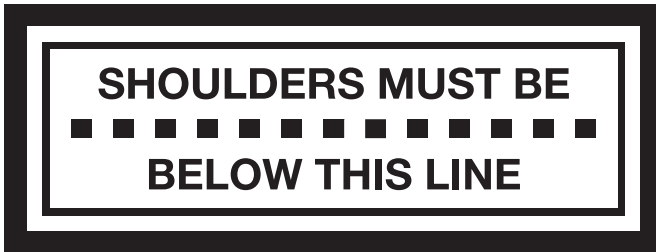

Children are at risk of serious injury if they move to booster seats too early.

Children that have outgrown the forward-facing child restraint are safest in a booster seat until their shoulders reach the upper shoulder height marker of the booster seat.

The child restraint is unsuitable for the occupant when the shoulders are above the upper marker. The child needs to be moved into the next form of child restraint eg. Type E booster seat or Type F booster seat when they reach the top shoulder height marker.

For the next child restraint refer to the "Restraint Guide" on page 6 and 12.

# Model CS9513

## Child Car Seat

Forward Facing

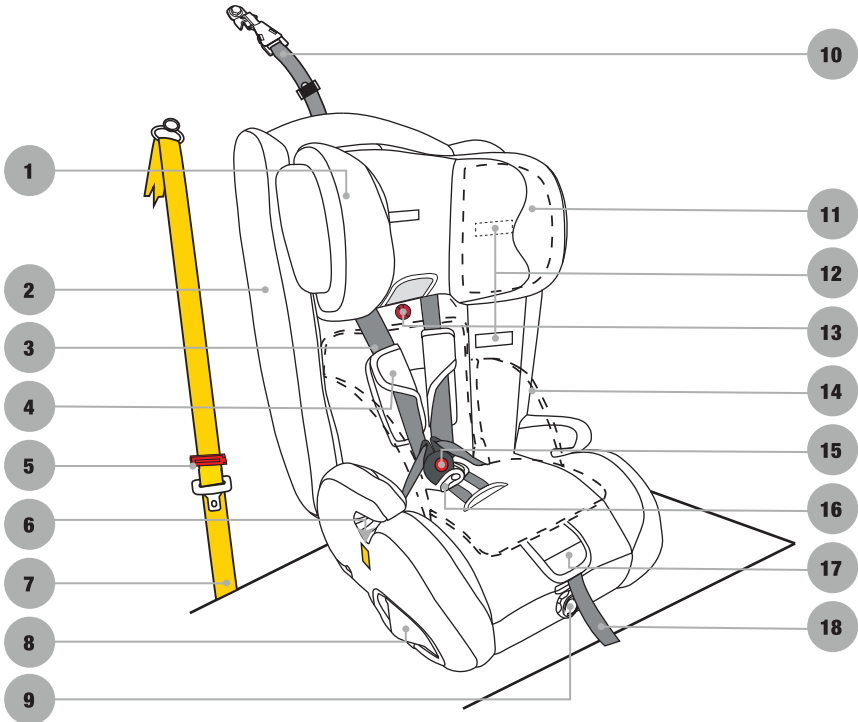

1. Adjustable Headrest (with Protect Plus)
2. Comfort Cover
  - Headrest
  - Apron
  - Backrest
  - Seat Base
3. Harness Straps
4. Shoulder Pads
5. **SAFE GRIP** Red Belt Clamp (if supplied with restraint)
6. "FORWARD-FACING SEAT BELT PATH" Marker (each side of restraint - coloured yellow)
7. Vehicle Seat Belt
8. Cup Holder (if supplied with restraint)
9. Recline Knob
10. Top Tether Assembly
  - Tether Strap
  - Adjuster
  - Attachment Clip
  - Anchor Fitting + Attachment Hardware
11. Active Air Pads (if fitted)
12. Shoulder Height Markers
13. "TrueFit" Headrest Adjustment
14. Padded Insert (if fitted)
15. Buckle Assembly
16. Buckle Pad
17. Harness Adjuster (under cover flap)
18. Harness Adjustment Strap

NOTE: Padded inserts can vary according to model. For detailed description and method of attachment for padded accessories refer to Accessories on pages 36-38.



### Next Type of Restraint

Refer to the 'RESTRAINT GUIDE' for the selection for the most appropriate next restraint (refer page 6). When the child has outgrown the child car seat, then you can use either of the following;

- **Booster seat** - Larger Type (E) or Type (F) booster seat with vehicle lap-sash seatbelt.
- **Vehicle Seat Belt** - Use the "Five Step Test" to determine whether your child is big enough to use the vehicle's seat belt assembly.

For more information Visit:  
[www.securesafe.com.au](http://www.securesafe.com.au)

### Five Step Test

- Step 1:** Can the child sit with their back against the vehicle seat back? (refer Figure 1).
- Step 2:** Do the child's knees bend in front of the edge of the seat? (refer Figure 2).
- Step 3:** Does the sash (shoulder) belt sit across the middle of the shoulder, not on the neck or out near the arm? (refer Figure 3).
- Step 4:** Is the lap belt sitting low across the hips touching the thighs? (refer Figure 4).
- Step 5:** Can the child stay seated like this for the whole trip? (refer Figure 5).

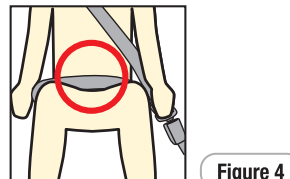
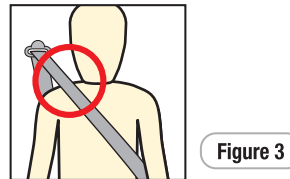
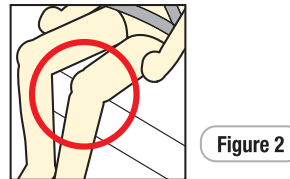
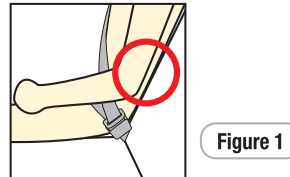
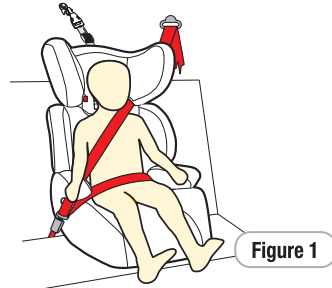

### Adjusting Recline Angle

Determine what restraint angle is preferred for the best installation of this restraint & comfort of your child.

#### TO RECLINE

**Step 1.** Fold out the recline foot (refer Figure 2).

**Step 2.** Position the restraint on the vehicle seat, turn the adjustment knob until the desired recline angle is achieved (refer Figure 3).

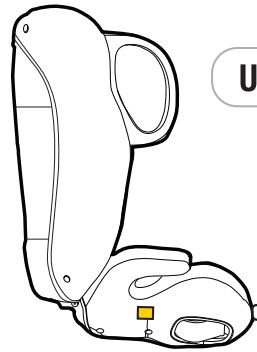

**UPRIGHT**

Figure 1

**RECLINE**

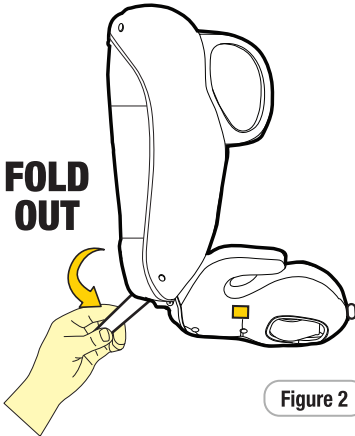

**FOLD OUT**

Figure 2



**TURN TO ADJUST**

Figure 3

#### Note:

When installing the CS9513, ensure the restraint contacts and is supported by the vehicle seat (refer Figure 4).

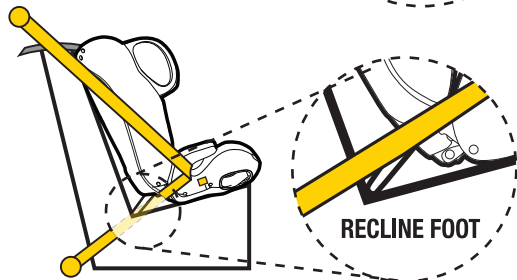

**RECLINE FOOT**

Figure 4

### Shoulder Height

#### Zone

The child's shoulder region.

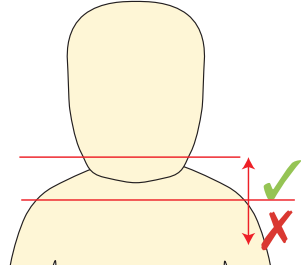

#### Slot Position

Nearest to the child's shoulders, but not more than 25mm below the child's shoulders.

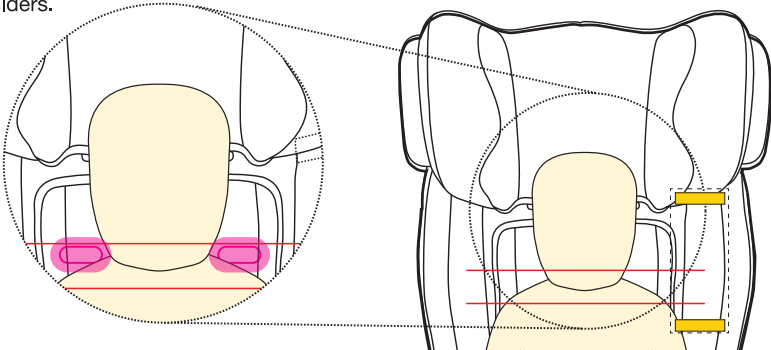

#### Headrest Position

Position the headrest above the shoulders, to ensure the straps are nearest to but not more than 25mm below the child's shoulders.

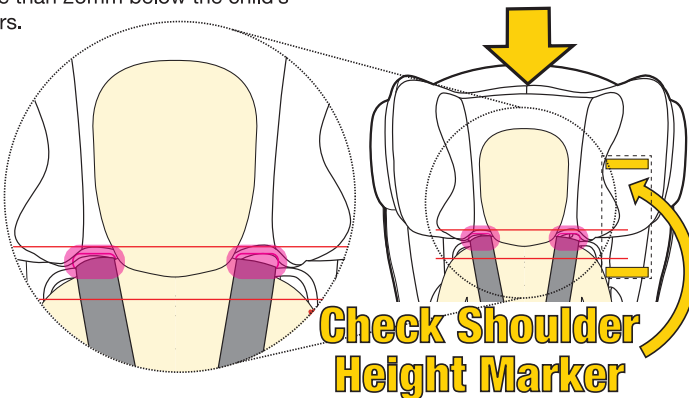

### Shoulder Height

The correct height for the shoulder straps is very important for the optimum performance of the restraint.



#### IMPORTANT

The shoulder straps must be positioned nearest to the child's shoulders, but not more than 25mm below the child's shoulders.

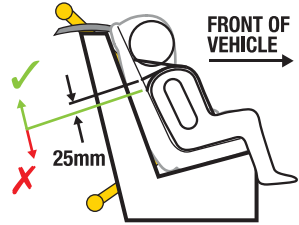

There is only one set of slots so the seat will always have the shoulder straps in place once the headrest is positioned correctly, just above the child's shoulders.

### Headrest & Harness Strap Height Adjustment

**Step 1:** Loosen the harness straps before adjusting the headrest (refer "Using Inbuilt Harness" page 25).

**You do not need to remove the restraint from the vehicle to adjust the harness or headrest positions.**

**Step 2:** To adjust the headrest, lift the "TrueFit" flap on the headrest cover. Turn the red "TrueFit" knob clockwise to unlock the headrest (refer Figure 1).

**Step 3:** Lift up or push down the headrest so that the shoulder strap slots are level with or slightly above your child's shoulders. If the headrest is just above the shoulders then the harness level will be correct (refer Figure 2 & 3).

**Step 4:** Release "TrueFit" knob so that it locks into position. Ensure that it has locked in position by gently pushing down on the headrest.



TrueFit

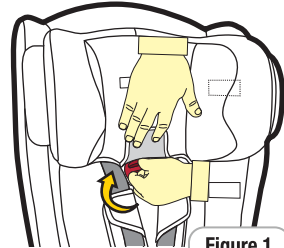

Figure 1



#### IMPORTANT

- For comfort ensure the bottom edges of the headrest are not contacting the child's shoulders.
- When lowering the headrest ensure the headrest apron does not bunch up behind the child's neck.

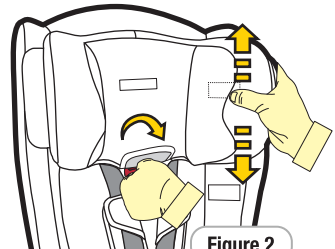

Figure 2

### Headrest & Harness Strap Height Adjustment

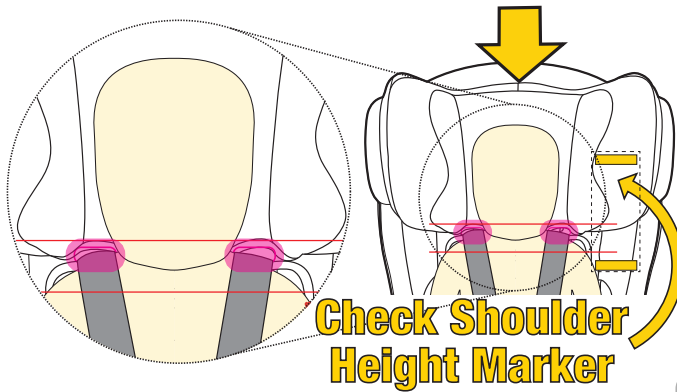

Figure 3



### IMPORTANT

**ENSURE THE HARNESS STRAPS ARE ALWAYS THREADED THROUGH THE HEADREST.**

Correct fitment of the harness is very important as it restrains the child in the restraint. The harness must fit firmly around the upper torso of the child and be positioned to ensure the child's arms and legs are free.

**Always adjust the height of the shoulder straps as the child grows, by adjusting the headrest height.**

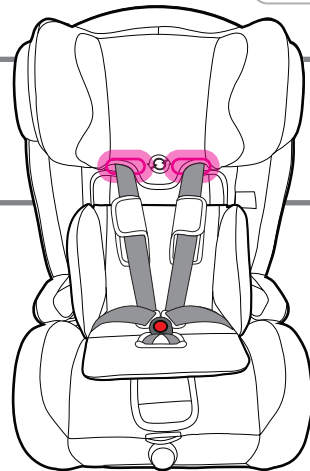

### IMPORTANT

- IF THE CHILD'S SHOULDERS TOUCH THE BOTTOM EDGES OF THE HEADREST SIDE WINGS, RAISE THE HEADREST TO THE NEXT HEADREST POSITION.
- THIS CHILD RESTRAINT DOES NOT REQUIRE THE STRAPS TO BE DISCONNECTED TO ADJUST THEIR HEIGHT, ONLY THE HEADREST NEEDS TO BE MOVED TO ADJUST THE SHOULDER STRAP POSITIONS.

### Buckle Height Adjustment

The buckle is supplied in a shortened position, if you want to alter the buckle height the following steps are required.

**Step 1:** Lift the buckle and determine the required buckle height (refer Figure 1).

**Step 2:** To alter the buckle height  
- Fold the flap forward and expose the adjustment plate.

**Step 3:** Lift the adjustment plate

**Step 4:** Adjust the webbing.

-To shorten the buckle 'Pull' excess webbing through the central plate.

-To lengthen the buckle 'Push' excess webbing through the central 3 bar plate.

Note: Do not shorten the buckle strap beyond the red indicator mark on the strap.

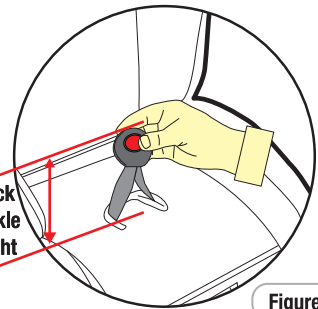

Figure 1

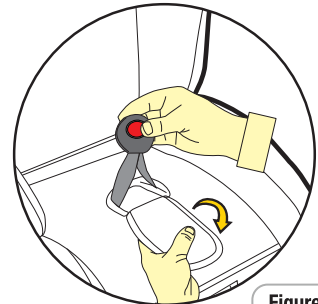

Figure 2

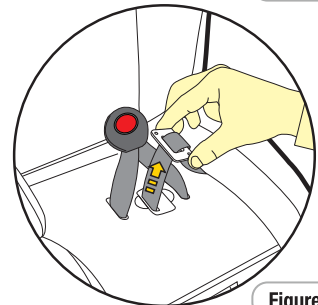
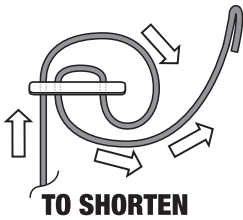

Figure 3



Note: When shortening the buckle ensure the buckle tongues have clearance above the upper thigh (refer page 24).

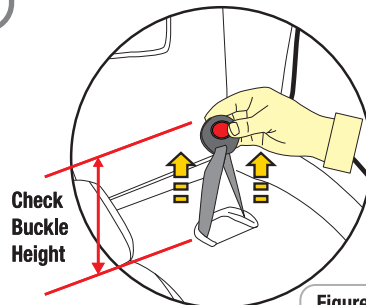
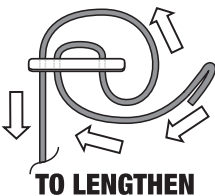

Figure 4

## Installing Using Vehicle Seatbelt

**Step 1:** Place the restraint in desired upright or reclined position, with the back against the back of the vehicle seat, directly in line with the anchorage point (refer Figure 1).

**Step 2:** Fold the rear of the restraint's base cover and foam forward to expose the seating surface of the base (refer Figure 2).

Fully extend the seat belt and pass the lap and sash sections of the vehicle belt under the first armrest, across the restraint base ensuring you pass the seat belt beneath the tongue in the plastic moulding (refer Figure 4 & 5) then under the second armrest, "CLICK" the buckle tongue into the buckle (refer to Figure 2, 3 & 4).

**Important notes:** The vehicle belt is now located across the restraint base. The belt path is shown by the arrows in Figure 3 & 4.

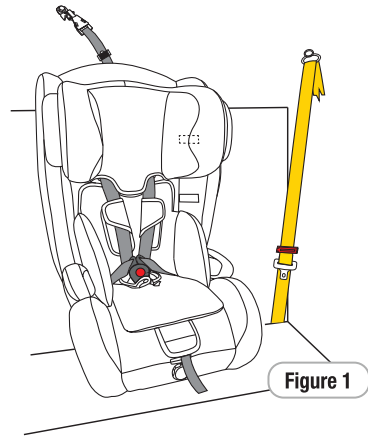

### IMPORTANT

Ensure that you use the **FORWARD-FACING BELT PATH** identified by either of the following labels.

**FORWARD FACING BELT PATH**

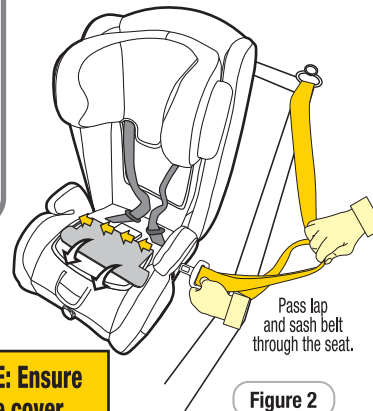

**NOTE:** Ensure the cover and foam pad are folded forward

### Installing Using Vehicle Seatbelt



## IMPORTANT

Ensure that you use the **FORWARD-FACING BELT PATH** identified by the following label.

### FORWARD-FACING BELT PATH



**Step 3:** Push down on the base of the restraint (with knee or hand) whilst pulling the sash section of the vehicle belt firmly up in direction of the yellow arrow in Figure 4. This will make the lap belt very tight across the restraint base. Whilst continuing to pull the sash section up (i.e. maintaining tightness of the lap section). Tighten sash section of belt across the base (refer Figure 6).

**Step 4:** Ensure the excess slack in the sash belt, is fed back towards the seat belt.  
**Ensure there are no twists in the seatbelt**

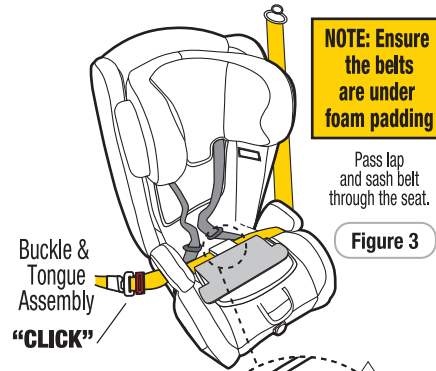

Figure 3

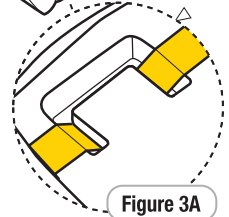

Figure 3A



Figure 4



### Installing Using Vehicle Seatbelt

#### Safe Grip (If Supplied)

\*Can be purchased separately visit [www.securesafe.com.au/](http://www.securesafe.com.au/)

#### SAFE GRIP BELT CLAMP

The **Safe Grip** (red belt clamp) **locks the lap belt** to ensure a firm installation, and avoids slack in the lap belt.

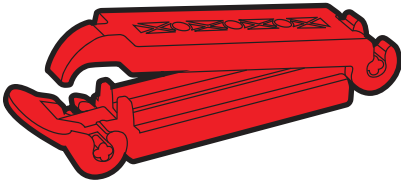

To install the **Safe Grip** (red belt clamp), open it and clamp the “sash section” **ONLY** of the vehicle seat belt by closing the barrel section of the red belt clamp in the direction of arrow 1 in Figure 5 and then locking with the toggle section by pushing in the direction of arrow 2 in Figure 5 when the **Safe Grip** (red belt clamp) is secured in place, the lap section is now tightly holding your child restraint in place, independent of the sash section. The **Safe Grip** (red belt clamp) must be removed when the child restraint is not installed to allow other users to use the seat belt as a lap/sash seat belt. Always keep the **Safe Grip** (red belt clamp) in pocket provided when not in use.

**NOTE:** Do not place the **Safe Grip** (red belt clamp) around both the lap and sash sections of the belt. This could cause the **Safe Grip** (red belt clamp) to break.

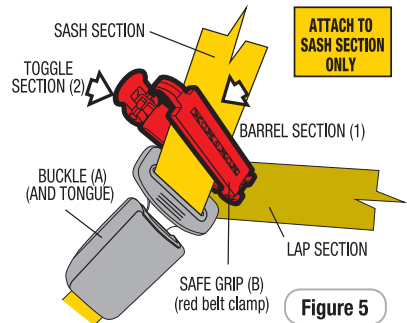

Figure 5

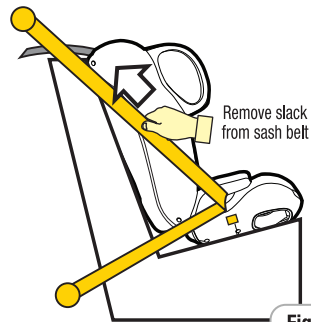

Figure 6



Figure 7

### Alternative Installation

To enable the most convenient installation of your new CS9513 restraint, the following alternative method of installation is provided. This method will ensure that you can remove all covers for washing without having to uninstall the restraint. When preparing for installation using the following steps:

- Step 1:** Unclip the press studs on the side of the seat base (refer Figure 1.1).
- Step 2:** Fold the armrest covers forward to expose the plastic armrests & base (refer Figure 1.2).
- Step 3:** Rotate the vehicle seat belt through the armrest, passing it across the shell and then pass it out through the other side of the seat (refer Figure 1.3).
- Step 4:** If the vehicle seat belt is long enough, it could be passed under the tongue in the centre of the restraint (refer page 19).
- Step 5:** Connect the seat belt by inserting the tongue into the buckle.
- Step 6:** Remove all slack from the seat belt;
- First feed all lap belt slack through to the buckle.
  - Then feed all slack back through the sash belt (towards the seatbelts anchorage point in the vehicle).
- Step 7:** Fold the armrest cover back over the armrest and secure the front press stud (the rear press stud can remain unclipped) (refer Figure 1.4).

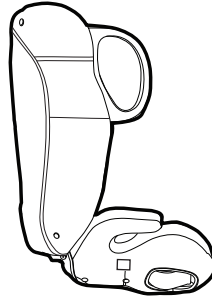

Figure 1.1

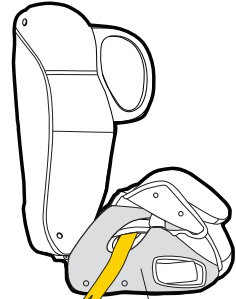

Figure 1.2  
EXPOSED  
PLASTIC  
SHELL

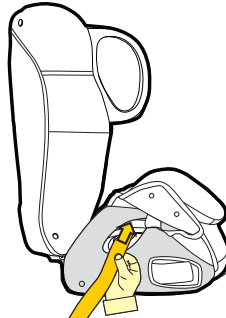

Figure 1.3

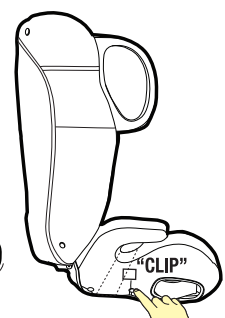

Figure 1.4

### Installing Using Top Tether Strap

**Note:** If no upper anchorage fitting is available refer to pages 39 & 40.

**Step 5:** Hook the attachment clip to the anchor fitting. **Ensure there are no twists in the top tether strap** (refer to Figure 8).

**Step 6:** Pull to tighten to remove all the slack, from the upper anchorage strap. Create a firm installation by tightening the upper anchorage strap (refer to Figure 9).

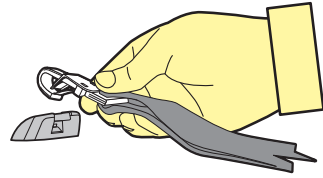

Figure 8

### NOTE

FOLLOWING THE INSTALLATION OF THE CHILD RESTRAINT A SMALL AMOUNT OF MOVEMENT IS DEEMED ACCEPTABLE.

**CAUTION: CHILDREN CAN BE INJURED OR RESTRAINTS AND TOP TETHER STRAP DAMAGED BY UNSECURED CARGO IN A COLLISION. SECURE OR REMOVE HAZARDOUS CARGO BEFORE USING THIS CHILD RESTRAINT.**

Always secure the loose end of the top tether strap to prevent it hanging out of the car or being accessible by the child.

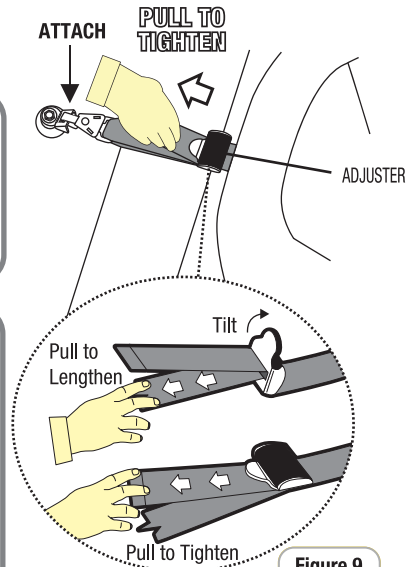

Figure 9

### Installing Using Top Tether Strap



#### WARNING

- Always use Top Tether strap to attach the child restraint to the vehicle.
- Do not use the restraint without the Top Tether strap correctly attached and adjusted.
- Do not use on any vehicle seat which faces sideways or rearwards.
- IF AN AIRBAG IS FITTED IN THE SEATING POSITION WHERE THE CHILD RESTRAINT IS TO BE FITTED, FOLLOW THE VEHICLE MANUFACTURER'S WARNINGS AND INSTRUCTIONS.
- Fit the restraint firmly to the car seat.

### Tether Storage

Store any excess webbing, from the top tether strap, in the storage pocket provided on the restraint (refer to Figure 10).

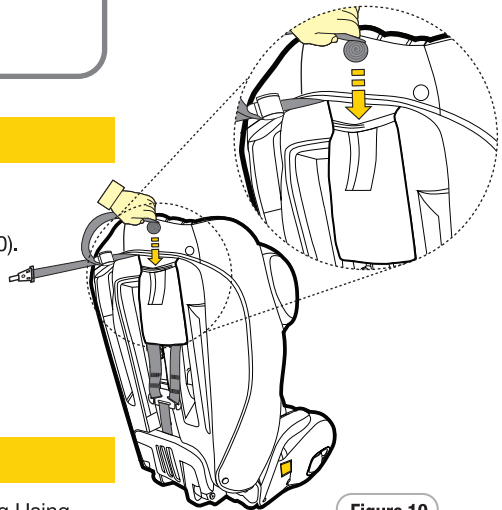

Figure 10

### (Using Lap Seat Belt)

**Step 1:** Follow the instructions covered by “Installing Using Vehicle Seatbelt” Steps 1 to 4 (refer pages 19-20).

**Note:** Do not use the Safe Grip (Red belt clamp) as there is no sash section of the seat belt.

### Using In-Built Harness

- Step 1:** Ensure the restraint has been installed and set up as per "Set Up" and "Installation" (refer pages 13-23).
- Step 2:** To lengthen the harness "LIFT" the harness adjuster (A) (refer Figure 1) whilst grasping both shoulder harness straps and pulling. Ensure shoulder straps are pulled equally on each side.
- Step 3:** Lay the two harness straps (with tongues) to the sides of the child restraint (refer Figure 1).
- Step 4:** Place the child in the restraint with legs either side of the buckle, place the harness over the shoulders and hips (refer Figure 2).

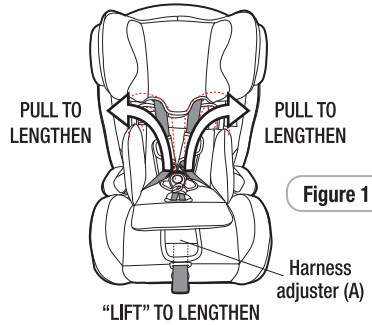

Figure 1

**Note:** Ensure the child is correctly seated, back into the restraint.

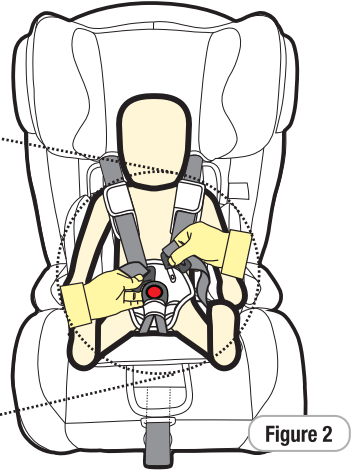
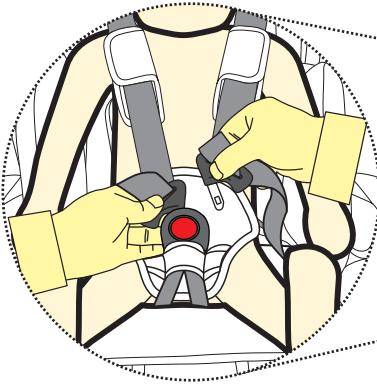

Figure 2



### IMPORTANT

#### KEEP BUCKLE LOW AS POSSIBLE

Always ensure buckle has clearance from the upper thighs (see indicated area Figure 3).

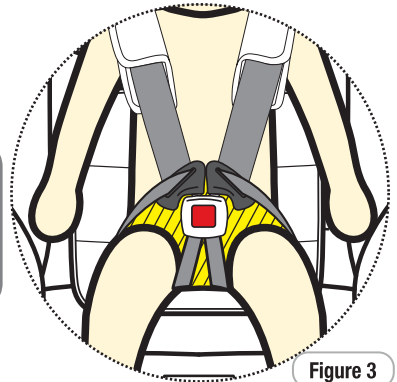
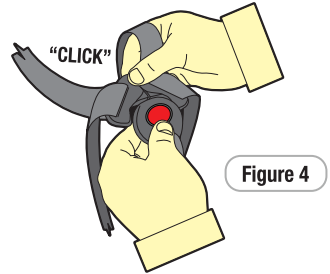
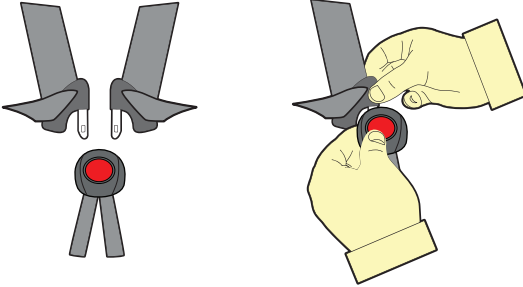

Figure 3

### Using In-Built Harness

**Step 5:** Insert either tongue into the buckle followed by the other tongue until a **“CLICK”** is heard. Should the second tongue not insert, press the red button and reinsert the tongues. Ensure secure engagement by pulling the harness strap (refer Figure 2 and 4).



**Step 6:** Remove all of the slack for the harness lap straps by pulling shoulder straps, then pull the harness adjustment strap to adjust harness to a comfortable but firm fit (refer Figure 5).



### IMPORTANT

If no “Click” can be heard or a secure engagement cannot be achieved refer to “Cleaning Buckle Harness” pages 29-31.

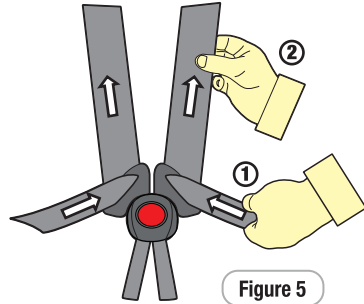

### Using In-Built Harness

- Step 7:**
- Ensure buckle is adjusted centrally in relation to the child. Adjust if necessary.
  - Check that the slack in the straps is removed.
  - The harness shoulder straps must fit firmly to the child.
  - A loose harness could result in serious injury in an accident.



### WARNINGS

- **DO NOT LEAVE CHILDREN UNATTENDED IN THE CAR.**
- Fit the harness firmly to the child.
- **A LOOSE RESTRAINT OR HARNESS IS DANGEROUS.**

- Step 8:** Check the harness tightness by the **PINCH TEST**, this is achieved by pinching the harness webbing at the shoulders (refer Figure 7)
- If you can pinch the harness strap, tighten more.
  - If your fingers slip off, then the harness is tight enough.

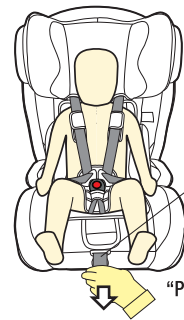
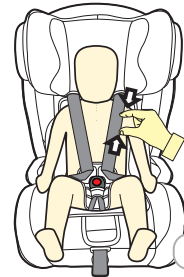

Figure 6

Harness adjuster strap (B)

"PULL" TO TIGHTEN



**PINCH TEST**

Figure 7

### To Release Child

- Step 1:** To release your child from the restraint simply press the buckle and lift the shoulder straps from the child's shoulders and carefully remove your child from the restraint.



### WARNINGS

- Always use a lap or lap-sash seat belt and upper anchorage strap to attach the child restraint to the vehicle.
- Do not use the restraint without the upper anchorage strap correctly attached and adjusted.
- Do not use on any vehicle seat which faces sideways or rearwards.
- IF AN AIRBAG IS FITTED IN THE SEATING POSITION WHERE THE CHILD RESTRAINT IS TO BE FITTED, FOLLOW THE VEHICLE MANUFACTURER'S WARNINGS AND INSTRUCTIONS.
- Do not use the restraint if the buckle is sluggish or does not provide an audible "Click" refer to Cleaning Instructions on pages 29-31.

# Care of Restraint

The child restraint cover has been manufactured to meet the Australian Standards requirements for flammability and toxicity to ensure your child's safety. The cover has also been designed to provide your child with comfort and support.

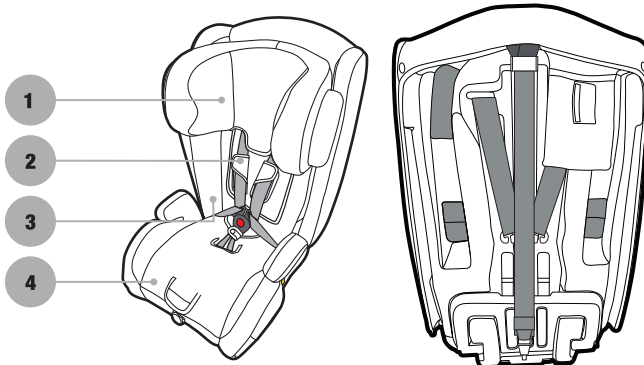

1. Headrest Cover
2. Apron Cover
3. Backrest Cover
4. Seatbase Cover

## VERY IMPORTANT

**Only replace the cover with SecureSafe supplied replacement cover with identical shoulder height markers or a replacement cover meeting AS/NZS 8005.**

## Care and Maintenance

Regular care of the restraint will ensure safety of your child.

- Check the webbing for fraying.
- Check the upper anchorage attachment clip to ensure retainer clip is still present.
- Ensure there are no cracks in moulding or the plastic moulding.
- Check the buckles “click” when you engage tongues and is not sluggish or sticky in operation.
- Ensure the buckle is free of fluff, liquid, or other matter that may enter the buckle slots. Clean the buckle if it is sluggish to engage (refer “Cleaning Harness Buckle” pages 29-31).
- Check the harness adjuster is operating and is clamping the webbing.
- If any part of the restraint is cracked or broken, seek repair immediately or replace the child restraint.



# Cleaning



## IMPORTANT

Use only mild soap and water to clean all parts of the CS9513 Child Car Seat.  
Do not use chemicals or cleaning agents  
Cold water only to be used and to be rinsed well  
Do not dry clean or tumble dry  
Do not bleach.

## Covers

The restraint has a flame retardant cover which is removable for cleaning. Cleaning instructions are on the care label attached to the cover. If a fluffy cover is fitted, then washing the cover prior to use will remove excess fluff.

The cover has been designed to protect your child when seated in the restraint. Care should be taken if children either eat or drink while in the restraint as some food or drink products may cause damage or marking to the cover. Wash or clean immediately. Do not pull sticky items from covers as the cover may be damaged - soak in water and gently remove.

Only machine wash on gentle cycle (hand washing is recommended). When washing the covers, ensure the hook and loop attachment strips are connected to eliminate other materials or garments being caught. Ensure that the hook and loop attachment strips are free of lint, this will ensure a positive engagement.

## Seat + Hardware

Use only mild soap and water to clean all webbing, metal and plastic parts of the restraint using a damp cloth.  
Do not use chemicals or cleaning agents.

## Harness Straps

Use only mild soap and water to clean all straps, using a damp cloth, you should avoid soaking the harness straps however they must be thoroughly dried (without excessive heat or never tumble dry). The harness straps should not be placed in a washing machine as this may cause damage to the stitching or even damage your washing machine.  
Do not use chemicals or cleaning agents.

# Cleaning

## Harness Buckle

If sticky liquids such as baby formula, fruit juice, etc. get inside your Buckle, it may become sluggish. An indication of a sluggish buckle is that you cannot hear a “CLICK” when engaging the Harness Tongues. To restore the Buckle to good working order it needs to be cleaned as follows:

- Step 1:** From the underside of the restraint remove the inspection plate (6 x screws) (refer Figure 1).
- Step 2:** Remove small screw securing the 3-bar plate (refer Figure 2).
- Step 3:** Pull the crotch 3-bar plate then turn 3-bar slide and push through the slot to remove the Buckle from one side of the restraint (refer Figure 3).
- Step 4:** From above the restraint pull the Buckle adjusting plate then turn and push the plate through the centre slot.
- Step 5:** From the underside of the restraint turn the Buckle adjusting plate and push through the right hand slot to remove the Buckle from the restraint (refer Figure 4).

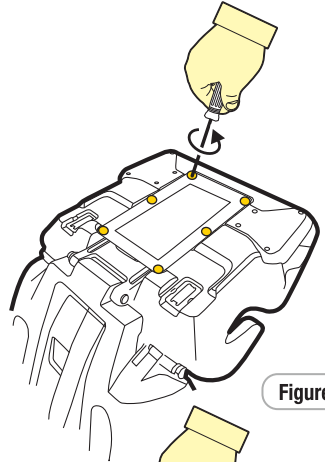

Figure 1

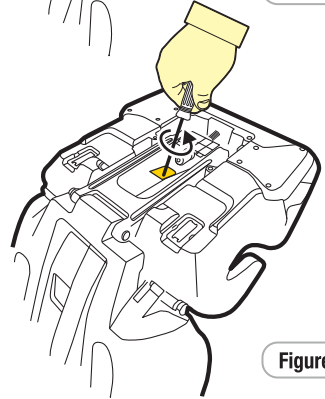

Figure 2

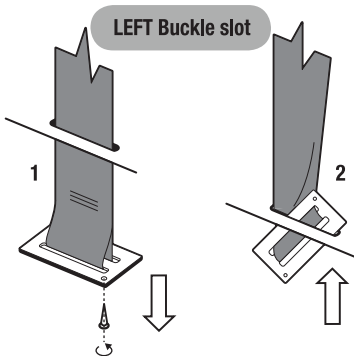

Figure 3

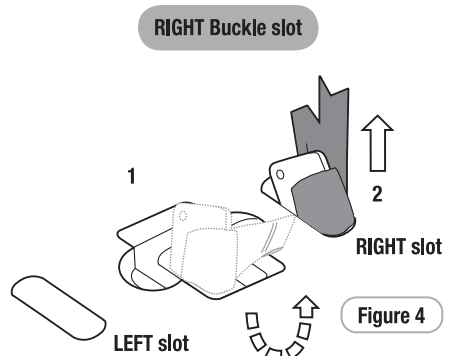

Figure 4

# Cleaning

## Harness Buckle

**Step 6:** Place the Buckle under warm (max. 40 degrees Celsius) running water as shown below. Let the water run through the mouth of the buckle for five minutes. Do not immerse the harness in water (refer Figure 5).

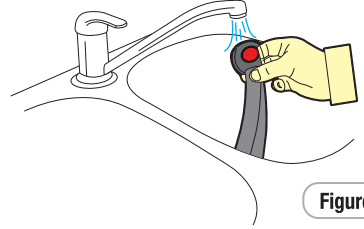

Figure 5

**Step 7:** Engage and disengage the Tongues and Buckles several times until a strong audible “CLICK” is heard when inserting the last tongue (refer Figure 6).

**Step 8:** If you still cannot hear a strong audible click after engaging the Tongues and Buckle, then repeat cleaning several times. If the Buckle cannot be returned to its original working condition then contact SecureSafe Customer Care:

**AU:** 1300 92 4632

**NZ:** 067 590 870

**Step 9:** If in working order refit the Buckle to the restraint with the red button facing out and feeding each 3-bar plate through appropriate slot (refer Figure 7).

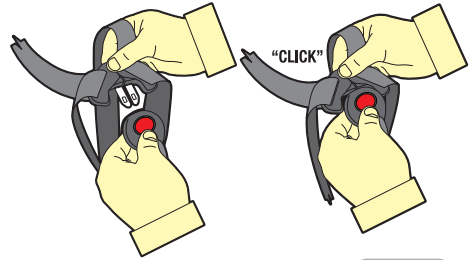

Figure 6

**Step 10:** Turn the Buckle adjusting plate and push through the right hand slot (refer Figure 7 & 8).

**Step 11:** Turn the Buckle 3 bar plate and push through the left hand slot (refer Figure 7 & 9).

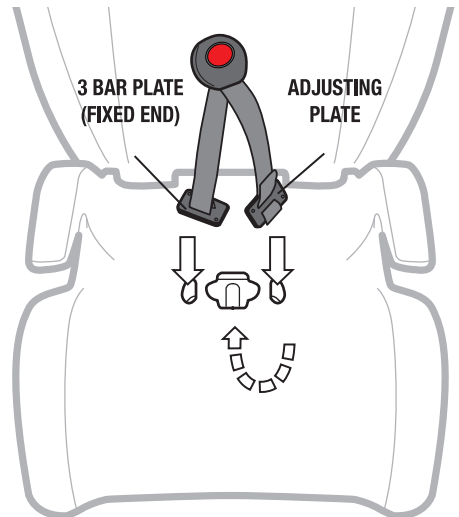

Figure 7

# Cleaning

## Harness Buckle

**Step 12:** From the underside of the restraint pull the Buckle adjusting plate then turn and push the plate up through the centre slot (refer Figure 8).

**Step 13:** From the underside of the restraint replace the small screw securing the 3-bar plate (refer Figure 10).

**Step 14:** From the underside of the restraint replace the inspection plate (6 x screws) (refer Figure 11).

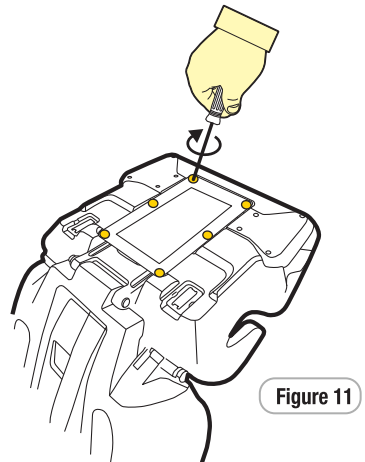
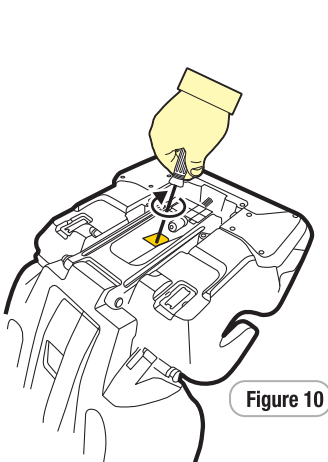
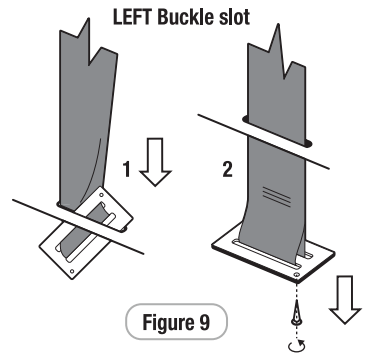
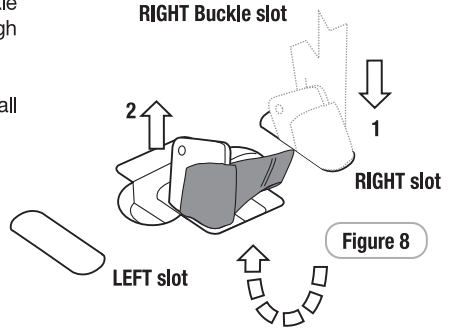

# Remove Covers

## Headrest

**Step 1:** Raise the headrest to highest position (refer Figure 1).

**Step 2:** Unclip the press studs located:

- 1 underside of headrest.
- 2 behind headrest.

**Step 3:** Remove cover

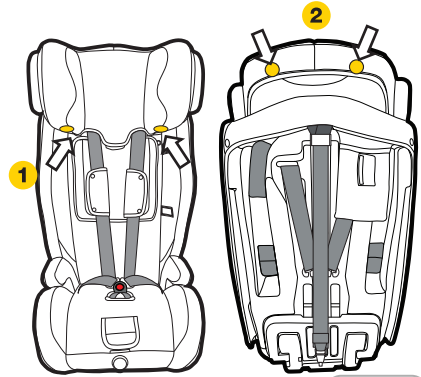

Figure 1

## Apron

**Step 1:** Unclip the press studs location 1 (refer Figure 2).

**Step 2:** Slide cover off the plastic apron to remove.

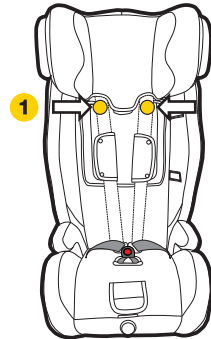

Figure 2

## Backrest

**Step 1:** Raise the headrest to highest position to access press studs.

**Step 2:** Unclip the press studs location 1 (refer Figure 3).  
NOTE: press studs may be obscured by headrest.

**Step 3:** Unclip the press studs located:

- 2 inside.
- 3 outside.

**Step 4:** Disconnect the 4 hook & loop connector located below the headrest/apron and remove the cover (refer Figure 3).

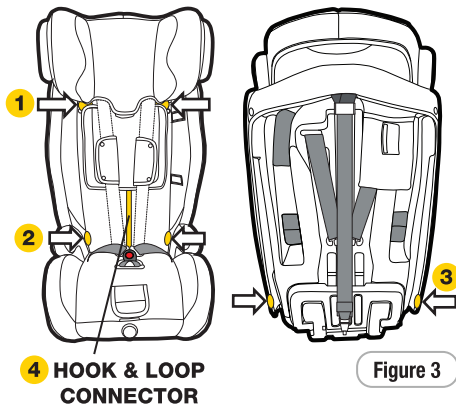

Figure 3

# Remove Covers

## Seatbase

**Step 1:** Fold the Buckle flap forward and pass the buckle through the cover.

**Step 2:** Unclip the press studs located (refer Figure 4):

**1** each side inner.

**2** each side outer.

**Step 3:** Remove cover.

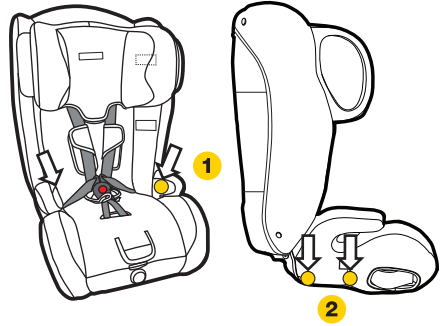

Figure 4

# Replace Covers

## Headrest

**Step 1:** Raise the headrest to highest position (refer Figure 1).

**Step 2:** Slide the cover over the headrest.

**Step 3:** Clip the press studs located:

- 1 underside of headrest.
- 2 behind headrest.

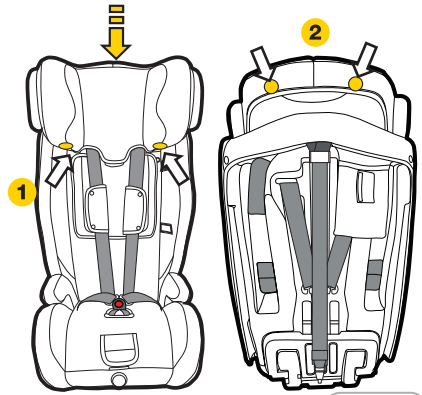

Figure 1

## Apron

**Step 1:** Slide the cover up and over the plastic apron (refer Figure 2).

**Note:** Ensure the comfort pad is in front of the plastic apron.

**Step 2:** Clip the press studs location 1.

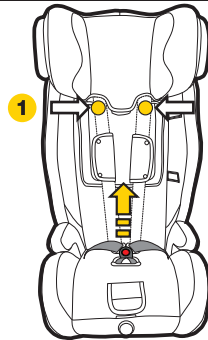

Figure 2

## Seatbase

**Step 1:** Slide the cover on to the seatbase (refer Figure 3).

**Step 2:** Fold the Buckle flap forward and pass the buckle through the cover.

**Step 3:** Clip the press studs located:

- 1 each side inner.
- 2 each side outer.

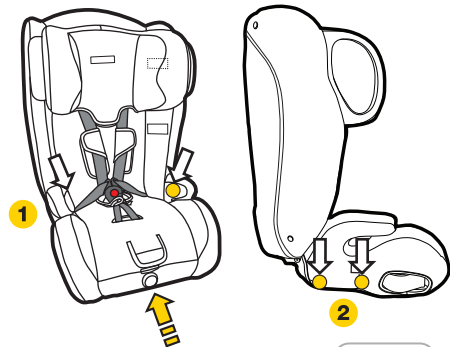

Figure 3

# Replace Covers

## Backrest

- Step 1:** Raise the headrest to highest position to access press studs.
- Step 2:** Slide the cover over the seatback and behind the headrest (refer Figure 4).
- Step 3:** Clip the press studs location **1** (refer Figure 5).  
NOTE: press studs may be obscured by headrest.
- Step 4:** Clip the press studs located:
- 2** inside.
  - 3** outside.
- Step 5:** Attach the **4** hook & loop connector located below the headrest/apron and secure the cover (refer Figure 5).

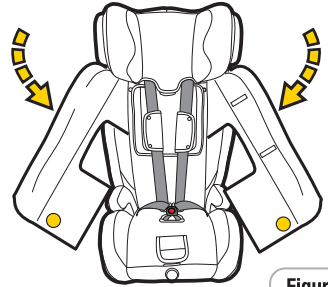

Figure 4

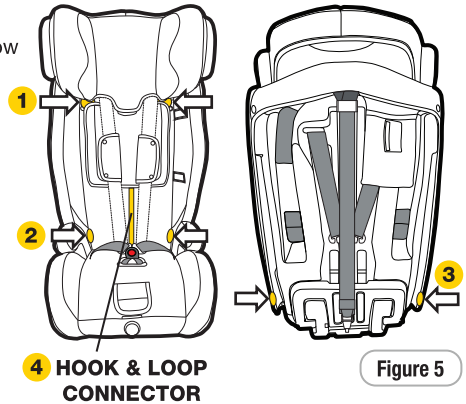

Figure 5

# Extension Straps

If required contact SecureSafe for nearest supply location. Extension straps, not included in this package, may be required for vehicles without a fixed parcel shelf.



Re order line numbers

CS111	300mm Length
CS112	600mm Length
CS113	200 - 900mm Adjustable Length

If required contact SecureSafe  
Customer Care 1300 92 4632 (AU)  
or 067 590 870 (NZ) for nearest  
supply location.



# Accessories

Follow the instructions covering the use of accessories provided with this child restraint or spare parts provided by SecureSafe for this restraint.

## **IMPORTANT**

Use of unauthorised aftermarket accessories (i.e items not provided in this box with the child restraint), can reduce the safety provided by the child restraint and may cause injury or death.

### **PADDED INSERTS** (if fitted)

The padded inserts are designed to add extra comfort for your child.

- Step 1:** Press to release Buckle tongues.
- Step 2:** Open the “press studs” and position the padded insert in the seat.
- Step 3:** Pass the harness straps over the insert and connect the “press studs”.
- Step 4:** Pull the Buckle and leg straps through the slot or opening in the insert.
- Step 5:** Connect both tongues into the buckle.

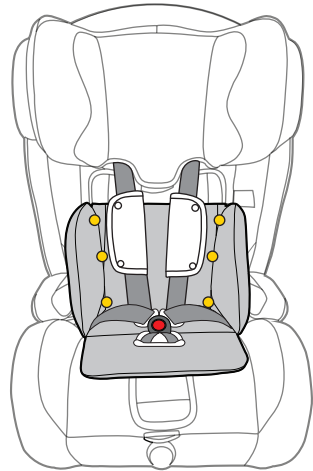

### **BUCKLE PAD** (if fitted)

The buckle pad is designed to add extra comfort for baby or child.

- Step 1:** Position the buckle pad behind the buckle and clip in the front. The release button should be clearly visible.

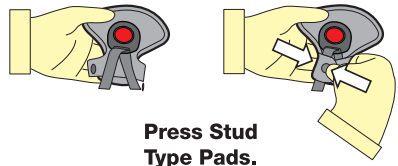

# Accessories

## SHOULDER PADS (if fitted)

### Alternative Pads

**Step 1:** Separate press-studs and remove the shoulder pads from harness

**Step 2:** To attach shoulder pads, ensure press studs face away from the child and re-attach.

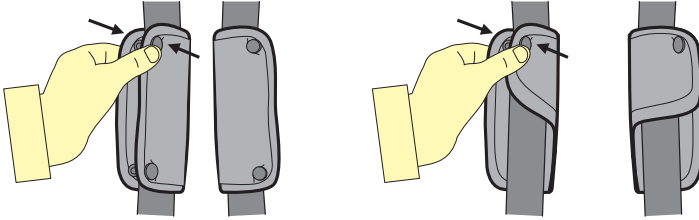

# Accessories

## SEAT PROTECTOR (if fitted)

The seat protector is designed to protect your car's seat.

### STANDARD

**Step 1:** Position the front flap with pockets, at the front of the rear seat and position the mat rearwards to obtain a flat fit.

### FULL LENGTH

**Step 1:** Position the front flap with pockets, at the front of the rear seat and position the mat rearwards to obtain a flat fit. (If required an additional flap has been provided to tuck in between the seat back & cushion).

**Step 2:** Position the back section up the seat back and use the plastic buckle & webbing strap to attach around the vehicle seat headrest (if the rear vehicle seat does not have a headrest then the strap could be used to attach around the child seats top tether after you have installed the child seat).

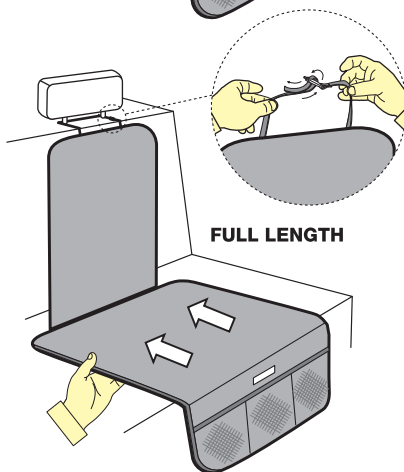
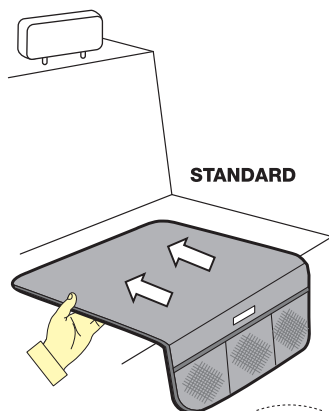

# Anchorage Fittings

Some vehicles may have an anchor fitting already fitted by the vehicle manufacturer.

If no anchorage points can be found refer to the vehicle manufacturer, or an authorised child restraint fitting station for the best location of an anchorage point.

Refer to the vehicle owners handbook or child restraint fitting station for the possible use of spacers.

Some vehicles may require the use of additional extension straps (not supplied with this child restraint).

If so ring SecureSafe on 1300 92 4632 (AU) or 067 590 870 (NZ) for nearest supply location.  
**ADDITIONAL EXTENSION STRAPS AVAILABLE:**  
 CS111 300mm Extension strap  
 CS112 600mm Extension strap  
 CS113 200 - 900mm Adjustable Extension strap



## WARNINGS

- Top tether strap and attachment clip must always be used
- Always ensure that the upper attachment clip is correctly engaged to the anchor fitting
- **THIS RESTRAINT MUST BE ATTACHED TO A CHILD RESTRAINT ANCHORAGE POINT IN THE CAR. REFER TO CAR OWNER'S HANDBOOK FOR LOCATION OF ANCHORAGE POINTS. REFER TO A CHILD RESTRAINT FITTING STATION IF NO CAR ANCHORAGE POINTS ARE IN THE MOTOR CAR.**
- **THIS RESTRAINT IS NOT SUITABLE FOR USE WHERE TOP TETHER STRAP MAY FALL INTO A SPLIT IN THE SEAT BACK OR OFF THE SIDE OF THE SEAT.**

## For cars fitted with a child restraint anchorage point

THIS RESTRAINT MUST BE ATTACHED TO A CHILD RESTRAINT ANCHORAGE POINT IN THE CAR.  
 LOCATE THE ANCHORAGE POINT BEHIND THE REAR SEATING POSITION  
 CONSULT THE CAR OWNER'S HANDBOOK FOR LOCATION OF ANCHORAGE POINTS.  
 REMOVE THE THREAD PLUG FROM THE PARCEL SHELF/FLOOR/ROOF AND INSTALL THE ATTACHMENT BOLT AS SHOWN IN FIGURE 1A & 1B.

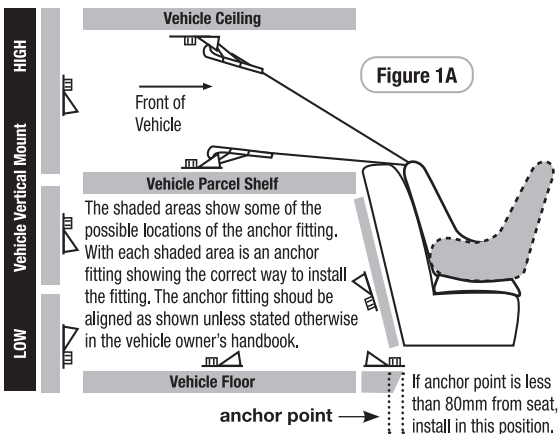

WARNING: If A.D.R. anchorage point is recessed, spacer(s) may be required.  
 Spacer Part No's are as follows:  
 10mm - CCS001;  
 5mm - CCS002

## UPPER ANCHORAGE FITTINGS

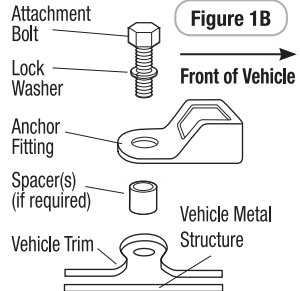

**CAUTION: DO NOT OVERTIGHTEN ATTACHMENT BOLT. MAXIMUM TORQUE IS 20NM.**

# Anchorage Fittings

## For cars not fitted with a child restraint anchorage point

### For Sedans Only

Drill a 9mm diameter hole in the parcel shelf on the centre line of the seating position as shown in Figure 1C. Hole must be no closer than 200mm from the front of the back seat. Install the anchor bolt as shown in Figure 1D.

Note to Queensland purchases: The installation of anchorage points must be approved by authorised officers appointed by Queensland Transport. Authorised officers can be sourced from all Queensland Transport Customer Service and Queensland Ambulance Service Centres.

### For Vehicles other than Sedans

In Australia, consult your nearest child restraint fitting station of traffic authority for vehicle inspection to find the best, correct position for the placement of the anchorage point, and for the correct attachment bolt length use of spacers.

In New Zealand consult the agent of the vehicle.

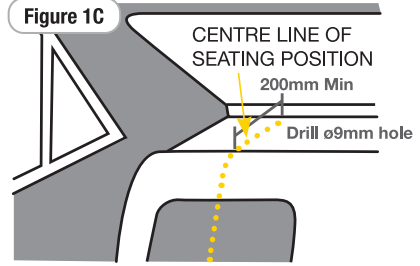

### UPPER ANCHORAGE FITTINGS FOR SEDANS ONLY

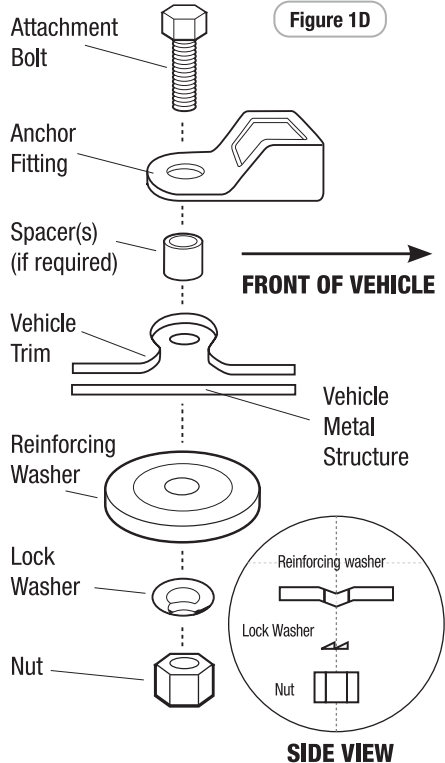

## WARNINGS

CHILD RESTRAINTS MUST NOT BE ATTACHED TO UNSOUND METAL OR WOOD OR SYNTHETIC STRUCTURES. WHEN DRILLING THE 9MM HOLE DO NOT DRILL THROUGH FUEL LINES, FUEL TANKS, ELECTRICAL WIRING OR RADIO SPEAKERS. WEBBING STRAPS MUST BE PROTECTED FROM SHARP CORNERS AND EDGES.

THE ANCHOR FITTING MUST BE USED ONLY AS DESCRIBED ABOVE. IT MUST NOT BE HOOKED ONTO ANY OTHER OBJECT.

# Insurers Information

If your restraint has been involved in a severe crash, you should destroy the restraint even if no damage is obvious. Some insurance companies offer vehicle insurance which covers or partially covers the replacement of your child restraint. Contact your insurance company for further details.

Your insurance company may require you to keep the child restraint for assessment, but do not use the child restraint after a severe crash. To assist you in making an accident insurance claim cut the following statement and include it with your claim.

## **NOTICE TO INSURANCE COMPANY CHILD RESTRAINT INVOLVED IN AN ACCIDENT**

All SecureSafe child restraints are manufactured to Australian/New Zealand Standards AS/NZS1754 which requires us to advise users of child restraints to "Destroy the entire restraint if it has been in use in a severe crash, even if no damage is obvious".

The Australian/New Zealand Standards committee, advise that this statement applies whether a child was in the child restraint or not. We consider a "severe crash" as being one where the main body structure of the vehicle is distorted.

There is no method of determining if the restraint has been damaged and we concur with the Australian/New Zealand Standards in recommending destruction of the child restraint.

This notice is to advise you of the requirements of the Australian/New Zealand Standards and our obligation in complying with the standards.

Please assist the owner of this restraint in their claim.

**INFASECURE PTY LTD** ABN: 52 149 173 660

Head Office and Registered Address  
110-114 Old Bathurst Rd, Emu Plains, NSW 2750  
P.O. Box 487, Emu Plains, NSW 2750

Customer Care  
**AU:** 1300 92 4632  
**NZ:** 067 590 870

[www.securesafe.com.au](http://www.securesafe.com.au)



# LIFETIME WARRANTY

ON SUPER STRONG BLOW MOULDED SHELL PRODUCTS

Register your product to receive **lifetime warranty\***, product updates and information.

 Please visit [securesafe.com.au/warranty-registration](https://www.securesafe.com.au/warranty-registration) to register your product.

## SecureSafe Warranty

InfSecure Pty Ltd warrants this product for twelve months from the date of purchase against failure due to manufacturing faults or faulty materials. Misuse, accidental damages, normal wear and tear are not covered by this warranty.

When used for commercial use the period is limited to six months. "Our goods come with guarantees that cannot be excluded under the Australian Consumer Law. You are entitled to a replacement or refund for a major failure and for compensation for any other reasonably foreseeable loss or damage. You are also entitled to have the goods repaired or replaced if the goods fail to be of acceptable quality and the failure does not amount to a major failure."

## Additional Warranty on Blow Moulded Child Restraints

Our blow moulded child restraints are covered against faulty materials and manufacturing when used under normal conditions and according to the instructions.

In the unlikely case that you do have a fault in relation to material quality or manufacturing that restricts your ability to use your Child Restraint normally, we will repair or replace the product within the following warranty periods from date of purchase:

- 12 month warranty for material and fabrics
- 2 year warranty for straps and webbing
- 5 year warranty for hardware and fittings
- Lifetime warranty\* on the manufacturing of the seat moulding

Please read your instruction manual carefully before using any of our products. The above express warranties do not apply where a failure or defect results from improper care, misuse or from normal wear and tear.

Refer to website for more details: [www.securesafe.com.au](https://www.securesafe.com.au)

\*Lifetime warranty refers to the life span of the seat which is 10 years from the Date of Purchase.

# Secure Safe

## INFA GROUP

 [secursafe.com.au](https://secursafe.com.au)

 [facebook.com/secursafeAU](https://facebook.com/secursafeAU)

 [instagram.com/secursafeAU](https://instagram.com/secursafeAU)

**INFASECURE PTY LTD** ABN: 52 149 173 660

Head Office and Registered Address  
110-114 Old Bathurst Rd,  
Emu Plains, NSW 2750  
P.O. Box 487, Emu Plains, NSW 2750

CUSTOMER CARE

**AU:** 1300 92 4632 **NZ:** 067 590 870 Email - [customer care@infa.com.au](mailto:customer care@infa.com.au)



**Australian  
Standard**

AS/NZS: 1754:2013  
Licence No. 25324-1  
SAI Global

**ISSUE: D**